

DC MOTORS CATALOG

DOGA

**DC MOTORS DC WORM GEARED MOTORS
ELECTRONIC MOTORS PLANETARY GEAR DC MOTORS**

MOTORES CC - MOTORREDUCTORES CC - MOTORES ELECTRÓNICOS - MOTORES CC CON REDUCTOR PLANETARIO

MOTEURS À CC - MOTORÉDUCTEURS À CC - MOTEURS ÉLECTRONIQUES - MOTEURS À CC AVEC RÉDUCTEUR PLANÉTAIRES

GLEICHSTROMMOTOREN - GLEICHSTROMSCHNECKENGETRIEBEMOTOREN - ELEKTRONISCHE MOTOREN - GLEICHSTROMPLANETENGETRIEBEMOTOREN

ELECTRONIC & SMART
MOTORS



STANDARD, CUSTOMIZED
& SPECIAL PROJECTS



SMALL & MEDIUM
SERIES



404

SYMBOLS SÍMBOLOS SYMBOLES ZEICHENERKLÄRUNG

	ENGLISH	ESPAÑOL	FRANÇAIS	DEUTSCH
BRO	Bronze	Bronce	Bronze	Bronze
CEL	Resin bonded fabric	Resina fenólica estratificada	Résine phénollique stratifiée	Hartgewebe
Fn	Nominal load	Fuerza nominal	Force nominale	Nennkraft
Fmax	Maximal load	Fuerza máxima	Force maximale	Maximale Festigkeit
i	Transmission ratio	Relación de reducción	Rapport de réducteur	Untersetzung
I	Current	Corriente	Courant	Stromaufnahme
I₀	No load current	Corriente en vacío	Courant à vide	Stromaufnahme im Leerlauf
I_a	Starting current	Corriente de arranque	Courant de démarrage	Anlaufstrom
I_n	Nominal current	Corriente nominal	Courant nominal	Nennstrom
IP	Protection degree	Grado de estanqueidad	Etanchéité	Feuchtigkeitsschutzklasse
M	Torque	Par	Couple	Drehmoment
Ma	Starting torque	Par de arranque	Couple de démarrage	Anzugsdrehmoment
Mk	Self-locking torque	Par de autobloqueo	Couple d'autoblocage	Selbsthemmungsmoment
Mn	Nominal torque	Par nominal	Couple nominal	Nenndrehmoment
η(%)	Efficiency	Rendimiento	Rendement	Wirkungsgrad
n	Speed	Velocidad	Vitesse	Geschwindigkeit
n₀	No load speed	Velocidad en vacío	Vitesse à vide	Geschwindigkeit im Leerlauf
n_n	Nominal speed	Velocidad nominal	Vitesse nominale	Nenngeschwindigkeit
P	Approximate weight	Peso aproximado	Poids approximatif	Gewicht (ca.)
P	Power	Potencia	Puissance	Leistung
P₁	Absorbed power (U.I)	Potencia absorbida (U.I)	Puissance absorbée (U.I.)	Aufgenommene Leistung (U.I)
P₂	Nominal power, useful	Potencia nominal, útil	Puissance nominale, utile	Abgegebene Leistung
PLA	Plastic	Plástico	Plastique	Kunststoff
U	Voltage	Tensión	Tension	Spannung
Un	Nominal voltage	Tensión nominal	Tension nominale	Nennspannung

2	SYMBOLS SÍMBOLOS SYMBOLES ZEICHENERKLÄRUNG
4	DOGA MOTORS RANGE GAMA MOTORES DOGA GAMME MOTEURS DOGA DOGA MOTORENSORTIMENT
5	CURVES CURVAS COURBES KURVEN
6	CUSTOMIZED & SPECIAL
7	MOTORS MOTORES MOTEURS MOTOREN
7	DC WORM GEARED MOTORS MOTORREDUCTORES CC SIN FIN MOTORÉDUCTEURS À CC À VIS SANS FIN GLEICHSTROMSCHNECKENGETRIEBEMOTOREN
28	ELECTRONIC MOTORS MOTORES ELECTRÓNICOS MOTEURS ÉLECTRONIQUES ELEKTRONISCHE MOTOREN
33	DC MOTORS MOTORES CC MOTEURS À CC GLEICHSTROMMOTOREN
44	PLANETARY GEAR DC MOTORS MOTORES CC CON REDUCTOR PLANETARIO MOTEURS À CC AVEC RÉDUCTEUR PLANETAIRE GLEICHSTROMPLANETENGETRIEBEMOTOREN
48	MOTOR APPLICATIONS APLICACIONES DE MOTORES APPLICATIONS MOTEURS ANWENDUNGSFÄLLE FÜR MOTOREN
50	DRIVE SYSTEMS DISTRIBUTION NETWORK

	MOTORS MOTORES MOTEURS MOTOREN
8	111
10	258
12	311
14	316 316 hall
18	317 317 hall
22	319 319 hall
26	359
30	311E
34	162
36	168
38	169
40	269
42	321
46	162P
47	168P

DRIVE SYSTEMS RANGE

MOTORS WITH WORM GEAR
MOTORREDUCTORES CC SIN FIN
 MOTORÉDUCTEURS À CC VIS SANS FIN
GLEICHSTROMSCHNECKENGETRIEBEMOTOREN

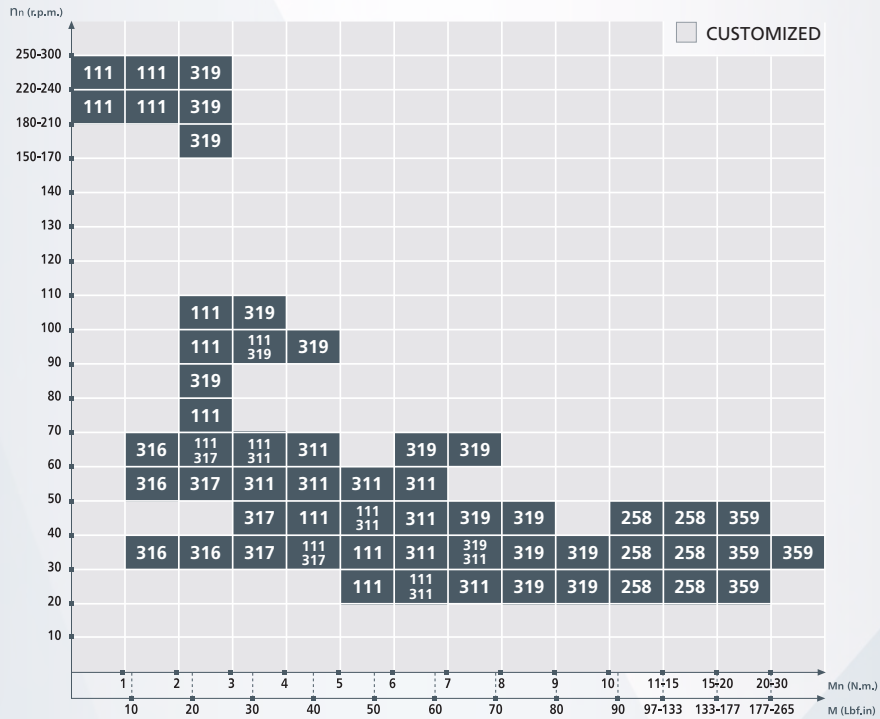

DC MOTORS
MOTORES CC
 MOTEURS À CC
GLEICHSTROMMOTOREN

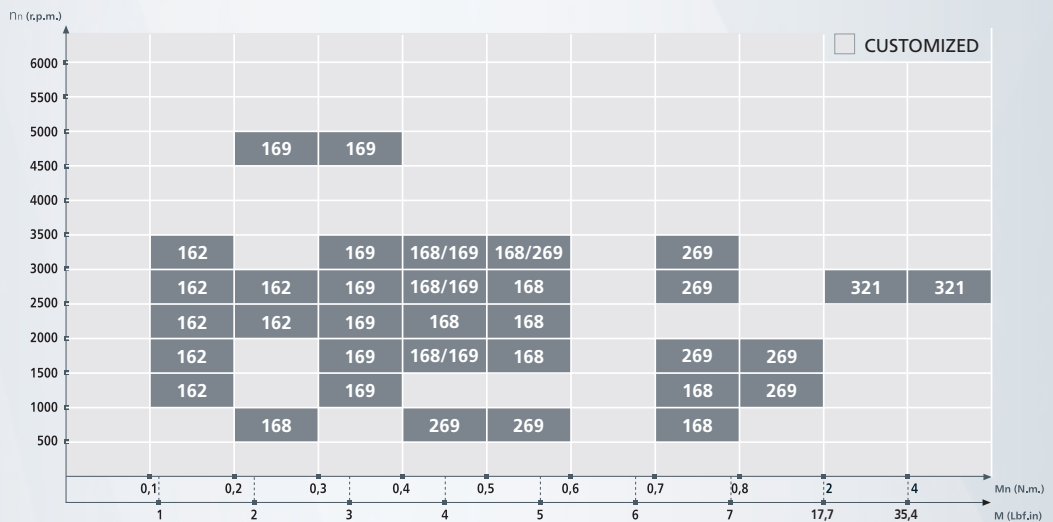

OTHER MOTORS
OTROS MOTORES
 AUTRES MOTEURS
ANDERE MOTOREN

SEE SPECIAL SECTION IN CATALOGUE
 VER SECCIÓN ESPECIAL EN CATÁLOGO
 CONSULTEZ SECTION SPÉCIAL DU CATALOGUE
 SEHEN SIE SONDERABSCHNITT IM KATALOG

characteristic curves características de las curvas caractéristiques des courbes Leistungskurven

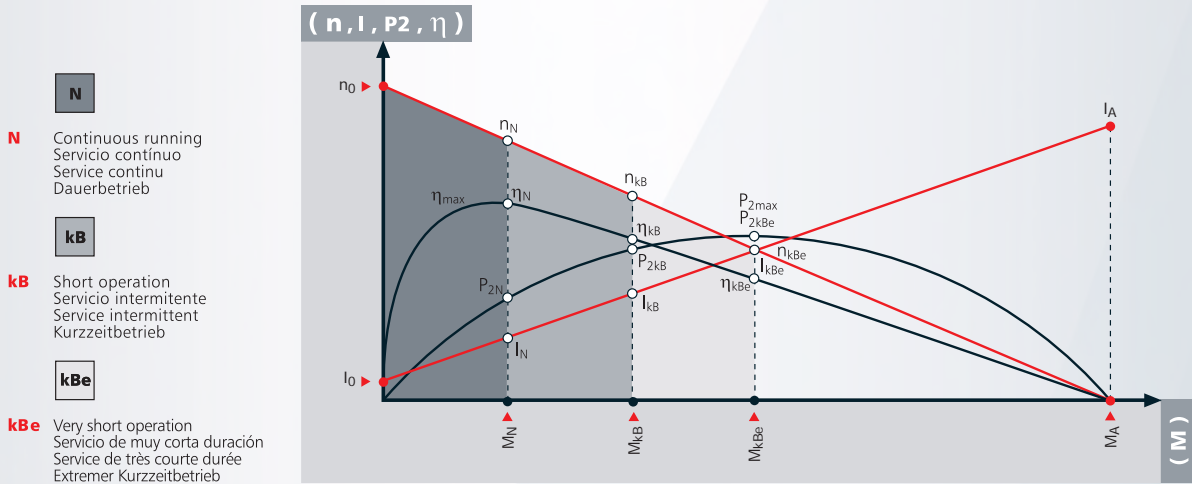

- N** Continuous running
Servicio continuo
Service continu
Dauerbetrieb
- kB** Short operation
Servicio intermitente
Service intermittent
Kurzeitbetrieb
- kBc** Very short operation
Servicio de muy corta duración
Service de très courte durée
Extremer Kurzzeitbetrieb

tolerance zones márgenes de tolerancia marges de tolerance Toleranzbereiche

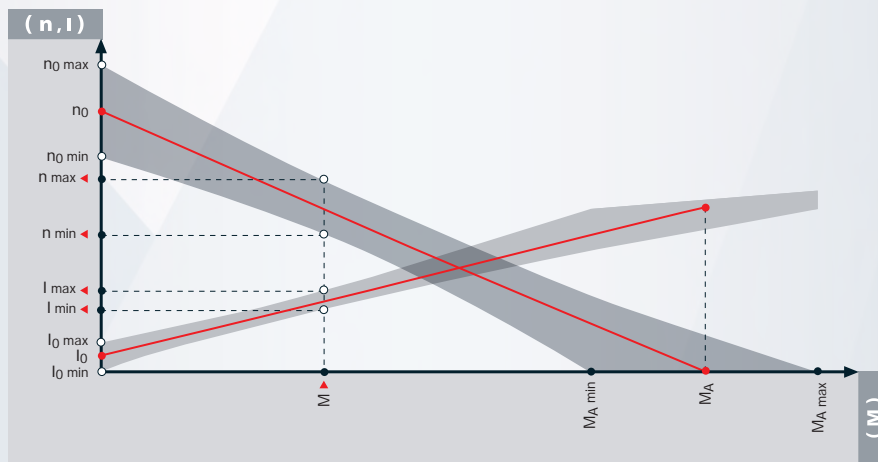

The stall values of starting torque (M_a) and starting current (I_a) in this catalog correspond to the torque and the current of the motor at room temperature with the output shaft locked.

The nominal values for voltage (U_n), current (I_n), torque (M_n) and speed (n) are for continuous operation (S1-VDE0530) in normal ambient conditions. The tolerance is $\pm 10\%$ for all values shown unless otherwise noted. Performance curves are with the motor at 20 degrees C temperature.

Les valeurs de blocage (M_a , I_a) correspondent au couple du moteur à froid avec axe de sortie bloqué.

Les valeurs nominales (U_n , I_n , M_n , n) sont déterminées pour un fonctionnement continu (S1-VDE0530) en conditions ambiantes normales. Tolérance $\pm 10\%$.

Les courbes sont avec moteur froid.

Los valores de bloqueo (M_a , I_a) corresponden al par y la corriente del motor en frío con el eje de salida bloqueado.

Los valores nominales (U_n , I_n , M_n , n) están determinados para funcionamiento continuo (S1-VDE0530) a condiciones ambiente normales. Tolerancia $\pm 10\%$.

Las curvas son con el motor en frío.

Die Werte für die Anlaufstrom und der Anzugsdrehmoment (M_a , I_a) entsprechen dem Drehmoment und der Strom des Motors in kaltem Zustand mit blockierter Abgangswelle.

Die Nominalwerte (U_n , I_n , M_n , n) werden ermittelt bei Dauerbetrieb (S1-VDE0530) unter normalen Umgebungsbedingungen. Toleranz $\pm 10\%$.

Die Kurven beziehen sich auf den Motor in kaltem Zustand.

CUSTOMIZED MOTORS

The DOGA DC motors and gearmotors in this catalog have been developed by our engineers to obtain an optimal adaptation to the needs of the client for all type of applications which come from a variety of industries.

At DOGA, we are specialized in adapting our "standard" products to meet the requirements of our customers. From a special connector or shaft, a selected winding that fits the specification of the motor, to even a brand new design of motor. DOGA does them all.

Also, DOGA is integrating ECU (Electronic Control Unit) in our motors to allow our customers for a precise control.

Our mission is to develop customized DC motors and gearmotors, up to 72 V, to satisfy the needs of our clients.

SPECIAL MOTORS

DOGA offers their technology and experience in the manufacture of DC motors and gearmotors, to develop specific solutions that operate on DC voltages to 72 Volts, using permanent magnet technology, both Brush type (PMDC) and Brushless (BLDC).

MOTORES A MEDIDA

Los motores y motorreductores de corriente continua DOGA de este catálogo han sido desarrollados por nuestros ingenieros para lograr una adaptación óptima a las necesidades del cliente en todo tipo de aplicaciones, en el sector automóvil o en el sector industrial.

En DOGA somos especialistas en adaptar nuestros productos "estándar" a los requerimientos del cliente: desde un conector especial, un eje a medida, un bobinado que ajuste las prestaciones del motor, hasta el diseño de un motor completamente nuevo.

DOGA también está integrando ECU (Unidad de Control Electrónico) en sus motores para permitir a sus clientes lograr un control preciso de su aplicación.

Nuestra misión es la de desarrollar motores y motorreductores de corriente continua a medida y hasta 72 V, para satisfacer las necesidades particulares de nuestros clientes.

MOTORES ESPECIALES

DOGA ofrece a sus clientes su tecnología y experiencia en la fabricación de motores y motorreductores de corriente continua, para desarrollar soluciones específicas que requieran una motorización en corriente continua y en baja tensión, hasta 72 V, en tecnología de imanes permanentes, con carbones o tecnología brushless.



DOGA can develop for YOU !!



MOTEURS SUR MESURE

Les moteurs et motoréducteurs à courant continu DOGA de ce catalogue ont été conçus par nos ingénieurs pour une adaptation optimale aux besoins du client et pour tout type d'application, tant pour le secteur automobile que pour l'industrie en général.

Chez Doga nous sommes spécialistes dans l'adaptation de produits "standard" aux nécessités du client. Des un connecteur spécial, l'axe à dimension spéciale ou l'induit pour ajuster les capacités du moteur, jusqu'à la conception totale d'un nouveau moteur.

DOGA intègre l'ECU (Unité de Commande Électronique) dans ses moteurs permettant un contrôle précis à ses clients.

Notre mission est de développer des moteurs et motoréducteurs à courant continu sur mesure, et jusqu'à 72V, pour satisfaire les besoins de nos clients.

MOTEURS SPÉCIALEMENT CONÇUS

DOGA offre à ses clients sa technologie et expérience dans la fabrication de moteurs et motoréducteurs c.c., afin de développer des solutions spécifiques demandant une motorisation à courant continu et de basse tension jusqu'à 72V, tant avec une technologie à aimants permanents qu'avec ou sans carbons (brushless).

KUNDENSPEZIFISCH

Die Gleichstrommotoren mit und ohne Getriebe in diesem Katalog sind von unseren Technikern entwickelt worden, um die beste Anpassung an die Kundenanforderungen zu erzielen, für jede Art von Anwendung, sei es im Automotivebereich, sei es in der übrigen Industrie.

Wir bei Doga sind Spezialisten darin, unsere "Standardmodelle" an die Anforderungen des Kunden anzupassen. Seien es eine besondere Steckverbindung oder ein besonderes Wellenende, eine Wicklung, die den Wirkungsgrad des Motors verfeinert bis hin zu einem vollständigen neuen Design.

DOGA ist die Integration von ECU (Electronic Control Unit) in unsere Motoren erlauben unseren Kunden für eine präzise Steuerung.

Wir sehen es als unsere Aufgabe an, Gleichstrommotoren mit und ohne Getriebe kundenspezifisch zu entwerfen, bis zu 72V Spannung, um die Bedürfnisse unserer Kunden zu erfüllen.

SPEZIALMOTOREN

DOGA bietet seinen Kunden Technologie und Erfahrung bei der Herstellung von Gleichstrommotoren mit und ohne Getriebe an, um spezifische Lösungen zu finden, die eines Gleichstromantriebs im Niederspannungsbereich bis zu 72 V bedürfen, in Permanentmagnettechnik ebenso wie in bürstenlosen Technik.



STANDARD, CUSTOMIZED
& SPECIAL PROJECTS

DC WORM GEARED MOTORS

DOGA

MOTORREDUCTORES CC SIN FIN
MOTORÉDUCTEURS À CC VIS SANS FIN
GLEICHSTROMSCHNECKENGETRIEBEMOTOREN

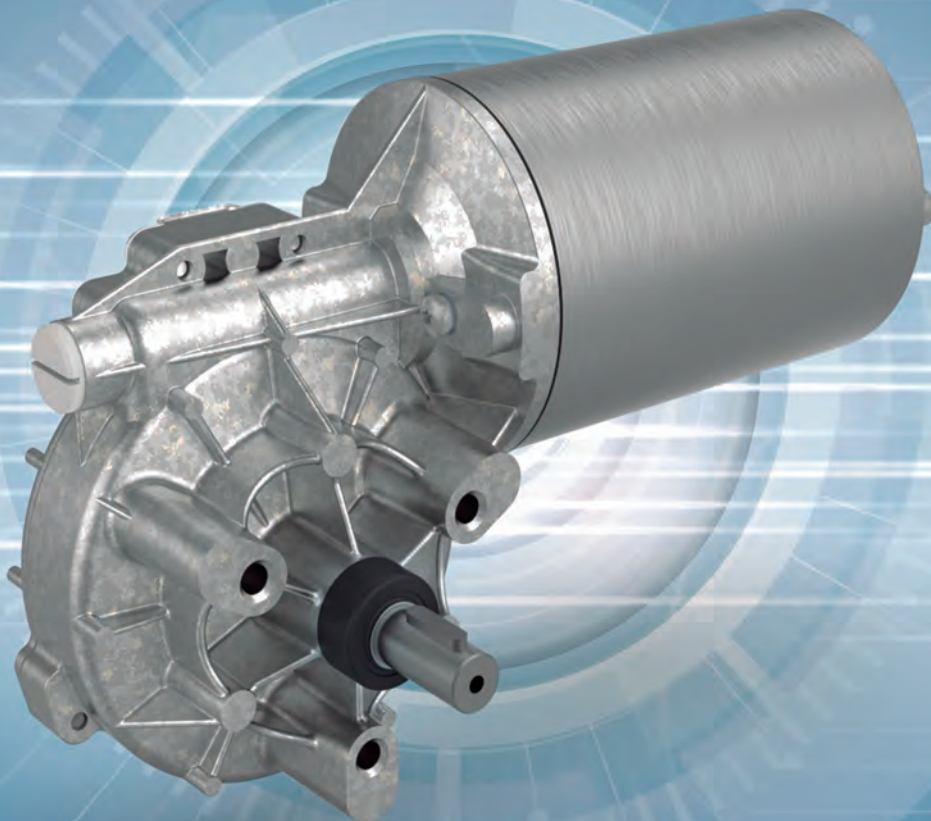

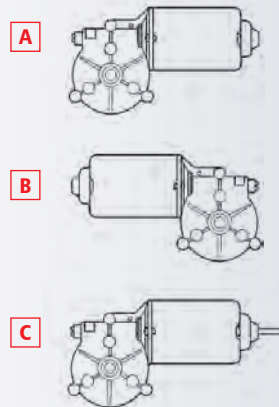
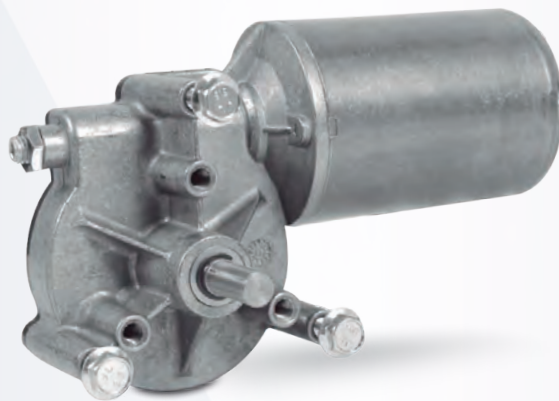

MOTOR FEATURES

REFERENCE NUMBER REFERENCIA REFERENZNUMMERN	NOMINAL VOLTAGE TENSION NOMINALE NENNSPANNUNG	NOMINAL TORQUE PAR NOMINAL COUPLE NOMINAL DREHMOMENT NOMINAL	NOMINAL SPEED VELOCIDAD NOMINAL VITESSE NOMINALE GESCHWINDIGKEIT NOMINAL	NOMINAL CURRENT CORRIENTE NOMINAL COURANT NOMINAL NOMINALSTROM	STARTING TORQUE PAR DE ARRANQUE COUPLE DE DEMARRAGE ANZUGSDREHMOMENT	STARTING CURRENT CORRIENTE DE ARRANQUE COUPANT DE DEMARRAGE ANZUGSTROM	SHAFT EJE ARBRE WELLE	CONNECTIONS CONEXIONES CONNEXIONS ANSCHLUSSART	WIRING DIAGRAM ESQUEMA ELECTRICO SCHEMA ELECTRIQUE SCHALTBLD	TRANSMISSION RATIO RELACION DE REDUCCION RAPPORT DE REDUCTEUR UNTERSATZUNG	APPROXIMATE WEIGHT PESO APROXIMADO PODS APPROXIMATIF GEWICHT (ca.)	WATERTIGHTNESS GRADO DE ESTANQUEIDAD ETANCHÉITÉ FEUCHTIGKEITSSCHUTZKLASSE	WHEEL MATERIAL MATERIAL RUEDA MATERIAU ROUE MAT. DES SCHNECKENRADES	DESIGN: A, B, C DISEÑO: A, B, C DESSIN: A, B, C ABBILDUNG: A, B, C	CURVE CURVA COURBE KURVE
	Un (V)	Mn (N.m./lbf.in)	Pn (r.p.m.)	In (A)	Ma (N.m./lbf.in)	Ia (A)				i	P (kg/lb)	IP			
11137112000	12	5 / 44.2	40	5	25 / 221.2	25	E22	C25	EE2	62:1	1.25 / 2.76	IP53	PLA	A	1
11137113000	24	5 / 44.2	40	2.5	25 / 221.2	13	E22	C25	EE2	62:1	1.25 / 2.76	IP53	PLA	A	1
11137612000	12	5 / 44.2	40	5	25 / 221.2	25	E23	C25	EE2	62:1	1.25 / 2.76	IP53	PLA	A	1
11137613000	24	5 / 44.2	40	2.5	25 / 221.2	13	E23	C25	EE2	62:1	1.25 / 2.76	IP53	PLA	A	1
11137612000E	12	5 / 44.2	40	5	25 / 221.2	25	E23	C25	F2	62:1	1.25 / 2.76	IP53	PLA	A	1
11137613000E	24	5 / 44.2	40	2.5	25 / 221.2	13	E23	C25	F2	62:1	1.25 / 2.76	IP53	PLA	A	1
11137632000	12	6 / 53.1	25	4	25 / 221.2	15	E23	C25	EE2	62:1	1.25 / 2.76	IP53	PLA	A	3
11137633000	24	6 / 53.1	25	2	25 / 221.2	8	E23	C25	EE2	62:1	1.25 / 2.76	IP53	PLA	A	3
11147613000	24	5 / 44.2	40	2.5	25 / 221.2	13	E23	C25	EE2	62:1	1.25 / 2.76	IP53	PLA	B	1
11190312000	12	3 / 26.5	70	6	25 / 221.2	34	E23	C25	EE2	62:1	1.25 / 2.76	IP53	PLA	A	2
11190313000	24	3 / 26.5	70	3	25 / 221.2	17	E23	C25	EE2	62:1	1.25 / 2.76	IP53	PLA	A	2
11190392000	12	1.5 / 13.2	240	8	10 / 88.5	46	E23	C26	EE1	49:4	1.25 / 2.76	IP53	PLA	A	4
11190393000	24	1.5 / 13.2	240	4	10 / 88.5	23	E23	C26	EE1	49:4	1.25 / 2.76	IP53	PLA	A	4
11190413000	24	5 / 44.2	40	2.5	25 / 221.2	13	E24	C25	EE2	62:1	1.30 / 2.87	IP53	BRO	A	1
11190942000	12	5 / 44.2	40	5	25 / 221.2	25	E52	C2	EE2	62:1	1.25 / 2.76	IP53	PLA	A	1
11191073000	24	1.5 / 13.2	240	4	14 / 123.9	23	E24/E53	C26	EE1	49:4	1.25 / 2.76	IP40	CEL	C	4
11191992000	12	3 / 26.5	100	6	20 / 177.01	48	E67	C26	F3	59:2	1.25 / 2.76	IP53	PLA	A	59
11191993000	24	3 / 26.5	100	3	20 / 177.01	24	E67	C26	F3	59:2	1.25 / 2.76	IP53	PLA	A	59

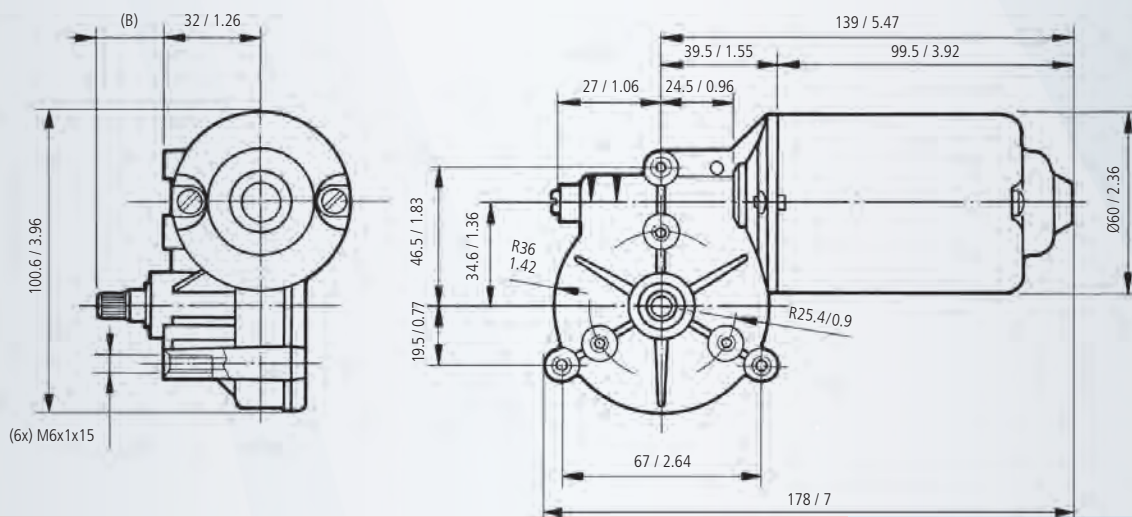

mm / inch

SHAFT EJE ARBRE WELLE

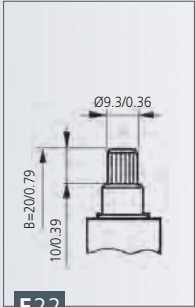

E22

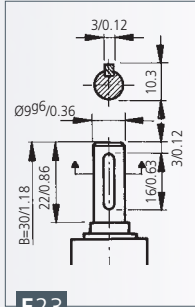

E23

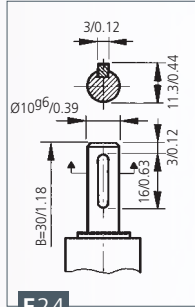

E24

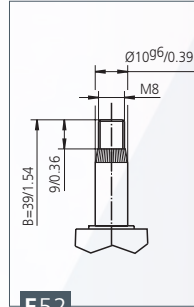

E52

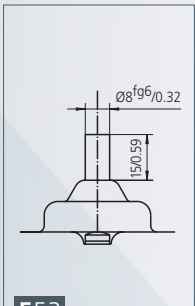

E53

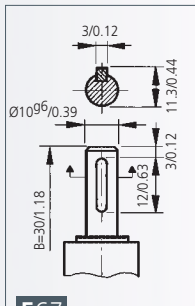

E67

CONNECTIONS **CONEXIONES** CONNEXIONS ANSCHLUSSART

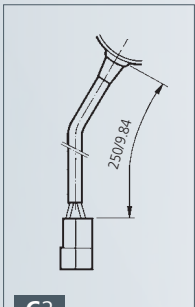

C2

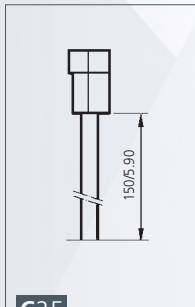

C25

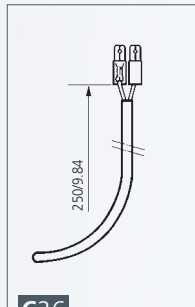

C26

WIRING DIAGRAM **ESQUEMA ELÉCTRICO** SCHEMA ÉLECTRIQUE SCHALTBILD

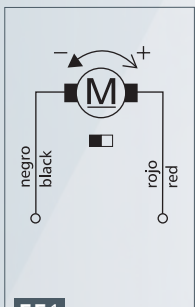

EE1

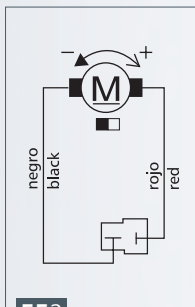

EE2

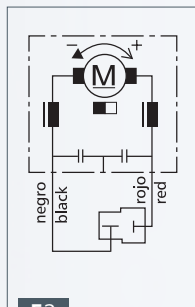

F2

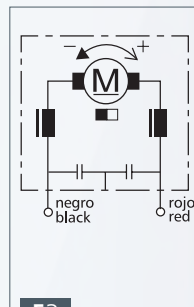

F3

CURVES **CURVAS** COURBES KURVEN

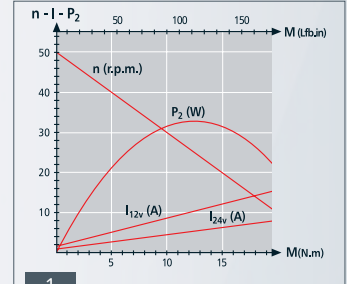

1

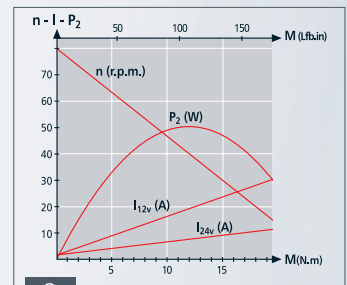

2

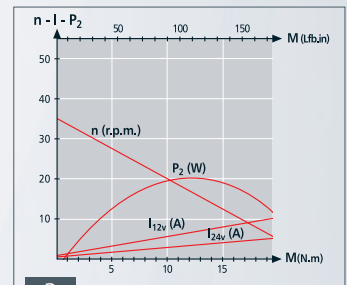

3

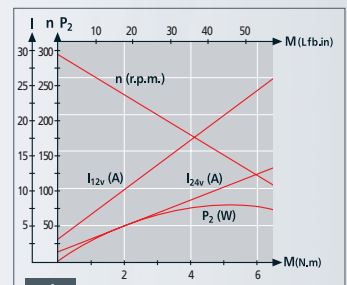

4

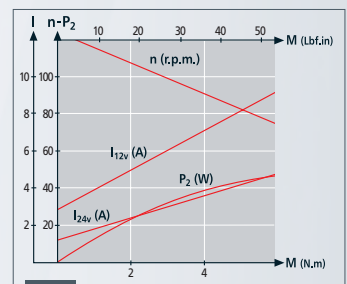

59

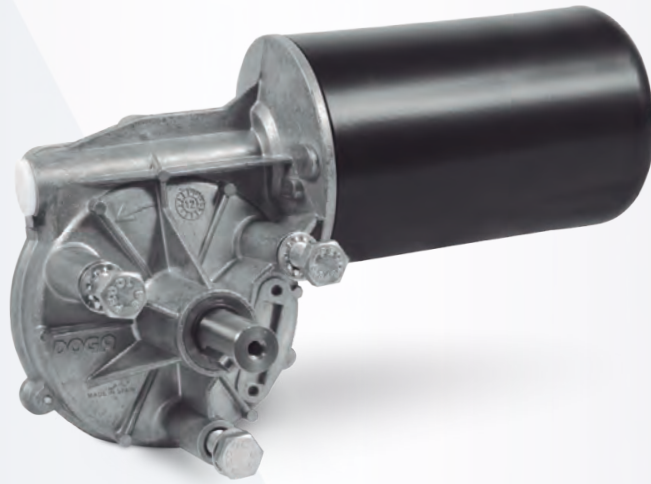

MOTOR FEATURES

REFERENCE NUMBER REFERENCIA REFERENZNUMMERN	NOMINAL VOLTAGE TENSION NOMINALE NENNSPANNUNG	NOMINAL TORQUE PAR NOMINAL COUPLE NOMINAL DREHMOMENT NOMINAL	NOMINAL SPEED VELOCIDAD NOMINAL VITESSE NOMINALE GESCHWINDIGKEIT NOMINAL	NOMINAL CURRENT CORRIENTE NOMINAL COURANT NOMINAL NOMINALSTROM	STARTING TORQUE PAR DE ARRANQUE COUPLE DE DEARRAGE ANZUGSDREHMOMENT	STARTING CURRENT CORRIENTE DE ARRANQUE COURANT DE DEARRAGE ANLAUFSTROM	SHAFT EJE ABBE WELLE	CONNECTIONS CONEXIONES CONNEXIONS ANSCHLUSSART	WIRING DIAGRAM ESQUEMA ELECTRICO SCHEMA ELECTRIQUE SCHALTBILD	TRANSMISSION RATIO RELACION DE REDUCCION RAPPORT DE REDUCTEUR UNTERSETZUNG	APPROXIMATE WEIGHT PESO APROXIMADO POIDS APPROXIMATIF GEWICHT (ca.)	WATERTIGHTNESS GRADO DE ESTANQUEIDAD ETANCHEITE FEUCHTIGKEITSSCHUTZKLASSE	WHEEL MATERIAL MATERIAU RUEDA MATERIAU ROUE MAT. DES SCHNECKENRADES	CURVE CURVA COURBE KURVE
	Un (V)	Mn (N.m./lbf.in)	nn (r.p.m.)	In (A)	Ma (N.m./lbf.in)	Ia (A)				i	P (kg/lb)	IP		
25817102000	12	15 / 133	25	10	80 / 708	42	E36	C34	F2	52:1	3.00 / 6.61	IP53	PLA	18
25817103000	24	15 / 133	25	5	80 / 708	21	E36	C34	F2	52:1	3.00 / 6.61	IP53	PLA	18
25837102000	12	15 / 133	25	10	80 / 708	42	E36	C34	EE2	52:1	3.00 / 6.61	IP53	PLA	18
25837103000	24	15 / 133	25	5	80 / 708	21	E36	C34	EE2	52:1	3.00 / 6.61	IP53	PLA	18
25837122000	12	12 / 106	40	12	80 / 708	55	E36	C34	EE2	52:1	3.00 / 6.61	IP53	PLA	19
25837123000	24	12 / 106	40	6	80 / 708	32	E36	C34	EE2	52:1	3.00 / 6.61	IP53	PLA	19
25890262000	12	12 / 106	40	12	80 / 708	55	E36	C34	EE2	52:1	3.00 / 6.61	IP53	CEL	19
25890263000	24	12 / 106	40	6	80 / 708	32	E36	C34	EE2	52:1	3.00 / 6.61	IP53	CEL	19

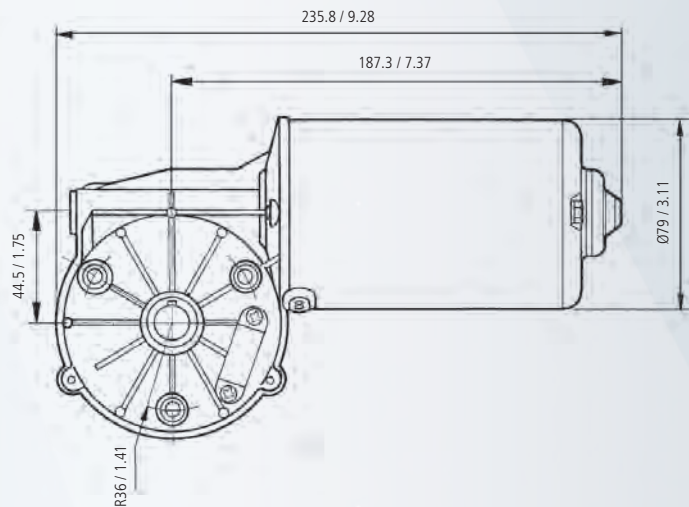
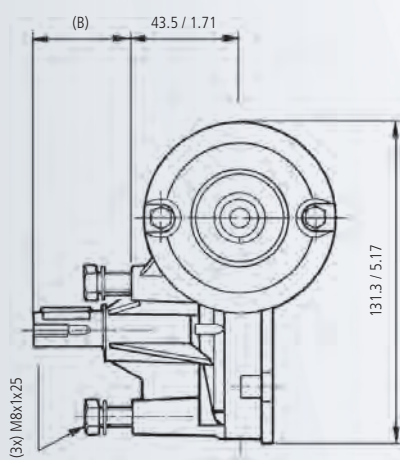

mm / inch

SHAFT EJE ARBRE WELLE

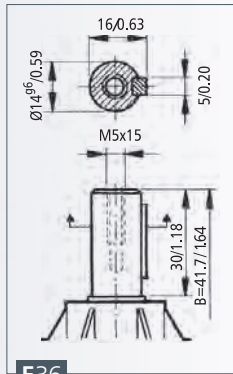

E36

CONNECTIONS **CONEXIONES** CONNEXIONS **ANSCHLUSSART**

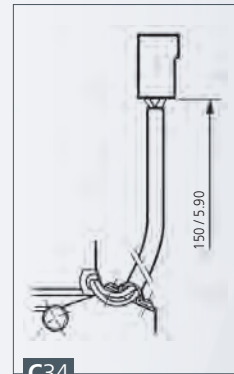

C34

WIRING DIAGRAM **ESQUEMA ELÉCTRICO** SCHEMA ÉLECTRIQUE **SCHALTBILD**

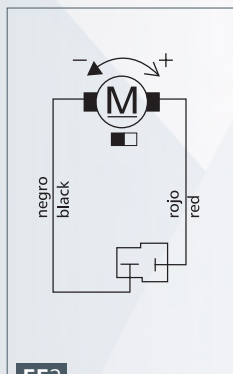

EE2

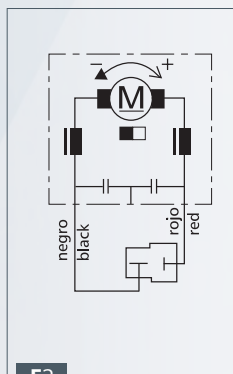

F2

CURVES **CURVAS** COURBES **KURVEN**

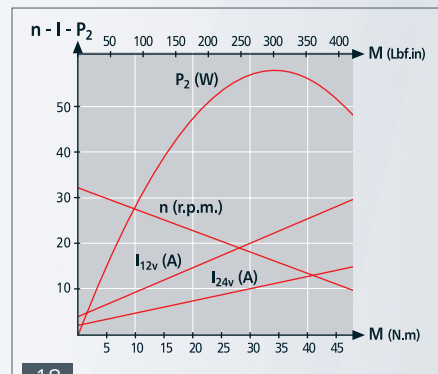

18

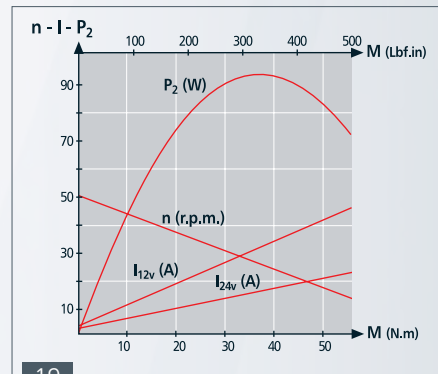

19

311



MOTOR FEATURES

REFERENCE NUMBER REFERENCIA REFERENZNUMMERN	NOMINAL VOLTAGE TENSION NOMINAL NENNSPANNUNG	NOMINAL TORQUE PAR NOMINAL DREHMOMENT NOMINAL	NOMINAL SPEED VELOCIDAD NOMINAL VITESSE NOMINALE GESCHWINDIGKEIT NOMINAL	NOMINAL CURRENT CORRIENTE NOMINAL COURANT NOMINAL NOMINALSTROM	STARTING TORQUE PAR DE ARRANQUE COUPLE DE DEMARRAGE ANZUGSDREHMOMENT	STARTING CURRENT CORRIENTE DE ARRANQUE COURANT DE DEMARRAGE ANLAUFSTROM	SHAFT EJE ARBRE WELLE	CONNECTIONS CONEXIONES CONNEXIONS ANSCHLUSSART	WIRING DIAGRAM ESQUEMA ELECTRICO SCHEMA ELECTRIQUE SCHALTBIKD	TRANSMISSION RATIO RELACION DE REDUCCION RAPPORT DE REDUCTEUR UNTERSETZUNG	APPROXIMATE WEIGHT PESO APROXIMADO POIDS APPROXIMATIF GEWICHT (kg)	WATERTIGHTNESS GRADO DE ESTANQUEIDAD ETANCHÉITÉ FEUCHTIGKEITSSCHUTZKLASSE	WHEEL MATERIAL MATERIAL RUEDA MATERIAU ROUE MAT DES SCHNECKENRADES	CURVE CURVA COURBE KURVE
	Un (V)	Mn (N.m./bf.in)	Pn (r.p.m.)	In (A)	Ma (N.m./bf.in)	Ia (A)				i	P (kg/lb)	IP		
311G4112000	12	7/62	33	4.5	35/309.8	25	E69	C48	F18	76:1	1.2 / 2.76	IP69K	PLA	80
311G4113000	24	7/62	33	2.5	35/309.8	14	E69	C48	F18	76:1	1.2 / 2.76	IP69K	PLA	80
311N4012000	12	6/53.1	45	5.5	35/309.8	43	E69	C48	F18	76:1	1.2 / 2.76	IP69K	PLA	81
311N4013000	24	6/53.1	45	2.7	35/309.8	26	E69	C48	F18	76:1	1.2 / 2.76	IP69K	PLA	81
311Y6022000	12	4/35	70	6	35/309.8	50	E69	C48	F18	76:1	1.2 / 2.76	IP69K	PLA	82
311Y6023000	24	4/35	70	3	35/309.8	25	E69	C48	F18	76:1	1.2 / 2.76	IP69K	PLA	82

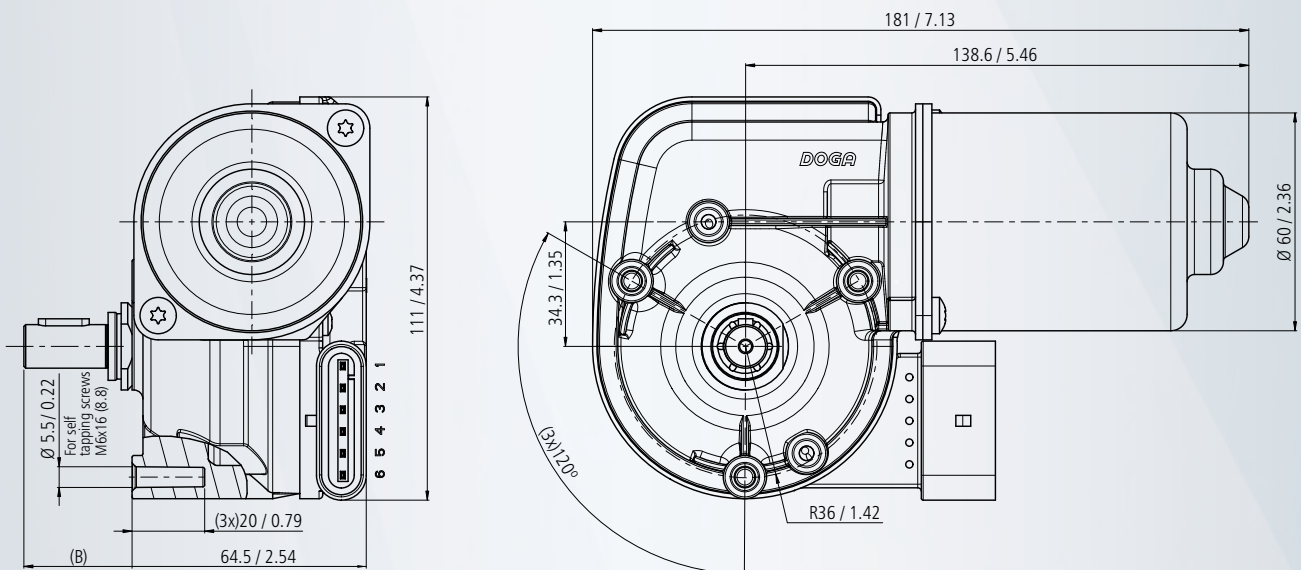

mm / inch

SHAFT **EJE** ARBRE **WELLE**

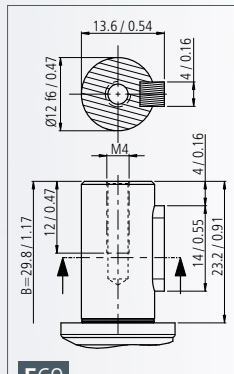

E69

CURVES **CURVAS** COURBES **KURVEN**

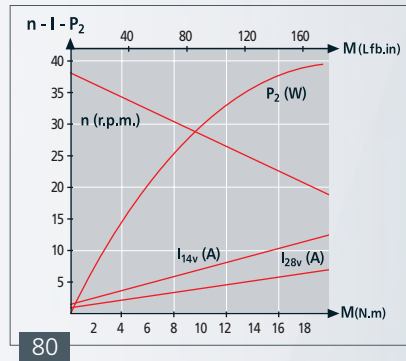

80

CONNECTIONS **CONEXIONES** CONNEXIONS **ANSCHLUSSART**

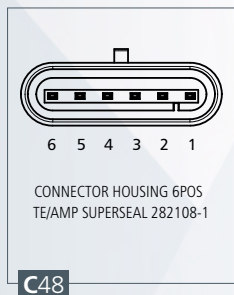

C48

Mating housing 6POS (not supplied)
 TE/AMP Superseal 282090-1

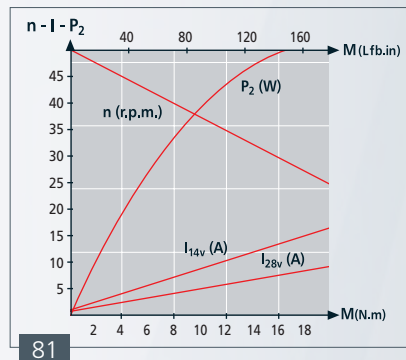

81

WIRING DIAGRAM **ESQUEMA ELÉCTRICO** SCHÉMA ÉLECTRIQUE **SCHALTBILD**

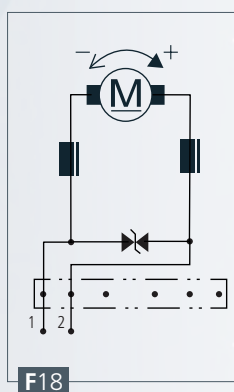

F18

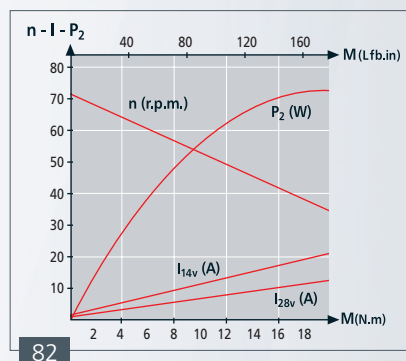

82

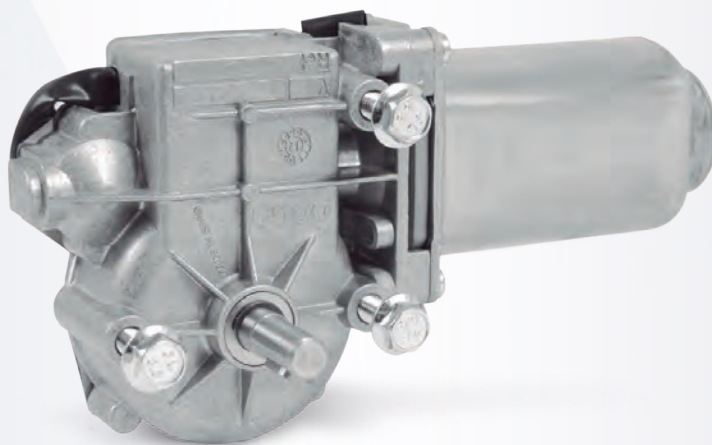

MOTOR FEATURES

REFERENCE NUMBER REFERENCIA REFERENZNUMMERN	NOMINAL VOLTAGE TENSION NOMINAL NENNSPANNUNG	NOMINAL TORQUE COUPLE NOMINAL DREHMOMENT NOMINAL	NOMINAL SPEED VELOCIDAD NOMINAL VITESSE NOMINALE GESCHWINDIGKEIT NOMINAL	NOMINAL CURRENT CORRIENTE NOMINAL COURANT NOMINAL NOMINALSTROM	STARTING TORQUE PAR DE ARRANQUE COUPLE DE DEMARRAGE ANZUGSDREHMOMENT	STARTING CURRENT CORRIENTE DE ARRANQUE COURANT DE DEMARRAGE ANLAUFSTROM	SHAFT EJE ARBRE WELLE	CONNECTIONS CONEXIONES CONNEXIONS ANSCHLUSSART	WIRING DIAGRAM ESQUEMA ELECTRICO SCHEMA ELECTRIQUE SCHALTBILD	TRANSMISSION RATIO RELACION DE REDUCCION RAPPORT DE REDUCTEUR UNTERSETZUNG	APPROXIMATE WEIGHT PESO APROXIMADO POIDS APPROXIMATIF GEWICHT (gr.)	WATERTIGHTNESS GRADO DE ESTANQUEIDAD ETANCHÉITÉ FEUCHTIGKEITSSCHUTZKLASSE	WHEEL MATERIAL MATERIAL RUEDA MATERIAU ROUE MAT. DES SCHNECKENRADES	CURVE CURVA COURBE KURVE
	Un (V)	Mn (N.m./lbf.in)	Pn (r.p.m.)	In (A)	Ma (N.m./lbf.in)	Ia (A)				i	P (kg/lb)	IP		
31627112000	12	2 / 17.70	38	3.4	10 / 88.5	12	E22	C30	EE4	62:1	0.90 / 1.98	IP10	PLA	56
31627113000	24	2 / 17.70	38	1.7	10 / 88.5	6	E22	C30	EE4	62:1	0.90 / 1.98	IP10	PLA	56
31627612000	12	2 / 17.70	38	3.4	10 / 88.5	12	E30	C30	EE4	62:1	0.90 / 1.98	IP10	PLA	56
31627613000	24	2 / 17.70	38	1.7	10 / 88.5	6	E30	C30	EE4	62:1	0.90 / 1.98	IP10	PLA	56
31627612000E	12	2 / 17.70	38	3.4	10 / 88.5	12	E30	C30	F4	62:1	0.90 / 1.98	IP10	PLA	56
31627613000E	24	2 / 17.70	38	1.7	10 / 88.5	6	E30	C30	F4	62:1	0.90 / 1.98	IP10	PLA	56
31697283000	24	2 / 17.70	38	1.7	10 / 88.5	6	E30	C30	EE4	62:1	0.90 / 1.98	IP10	BRO	56
31697312000	12	*1.5 / 13.27	65	6.0	10 / 88.5	22	E30	C30	EE4	62:1	0.90 / 1.98	IP10	PLA	57
31697313000	24	*1.5 / 13.27	65	3.0	10 / 88.5	11	E30	C30	EE4	62:1	0.90 / 1.98	IP10	PLA	57

* (VDE 0530) S3 - 10% (10 min.)

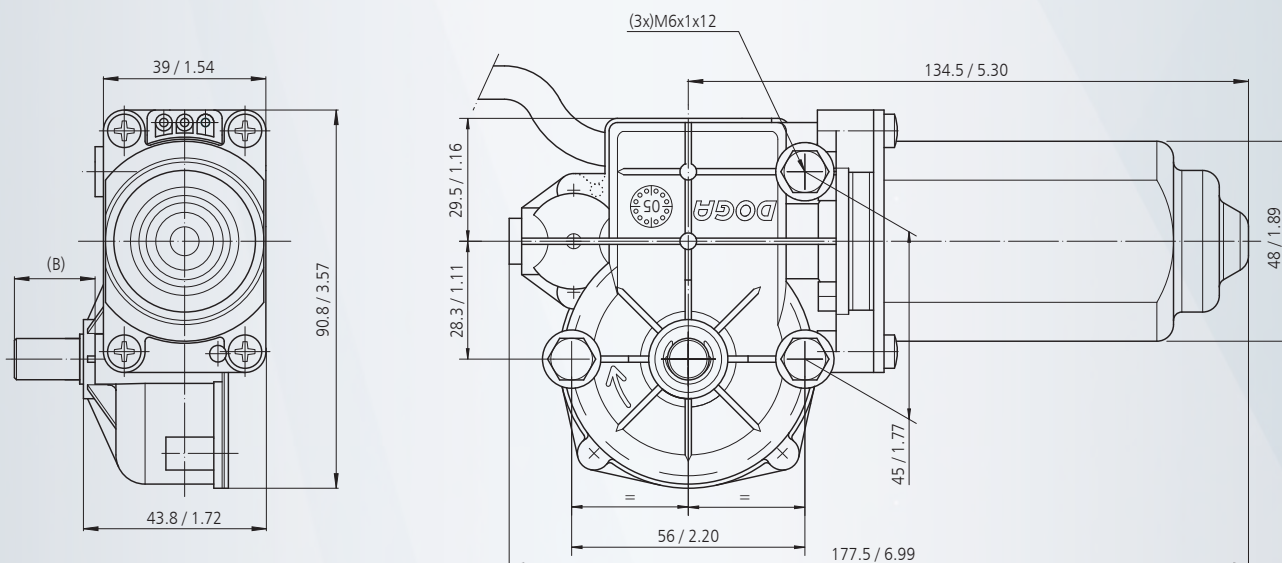

mm / inch

SHAFT **EJE** ARBRE **WELLE**

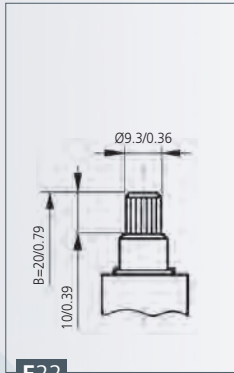

E22

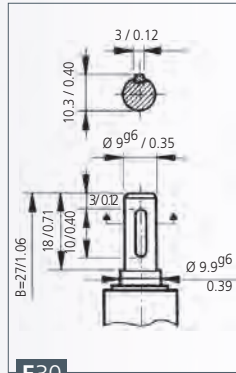

E30

CONNECTIONS **CONEXIONES** CONNEXIONS **ANSCHLUSSART**

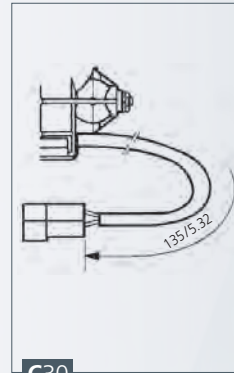

C30

WIRING DIAGRAM **ESQUEMA ELÉCTRICO** SCHEMA ÉLECTRIQUE **SCHALTBILD**

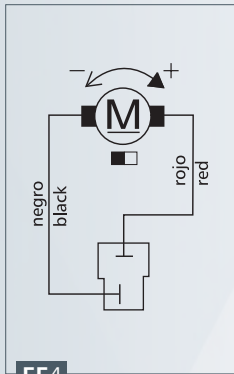

EE4

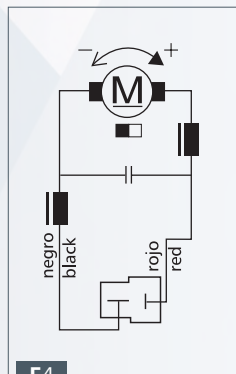

F4

CURVES **CURVAS** COURBES **KURVEN**

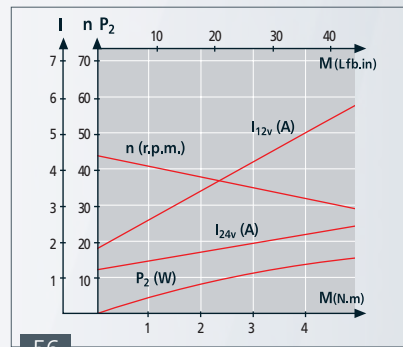

56

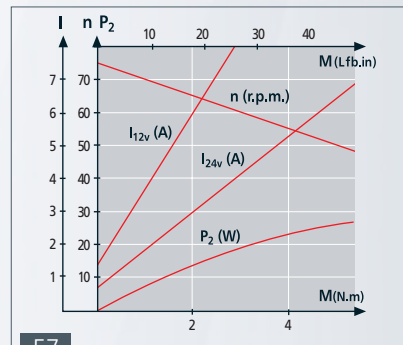

57

316 hall

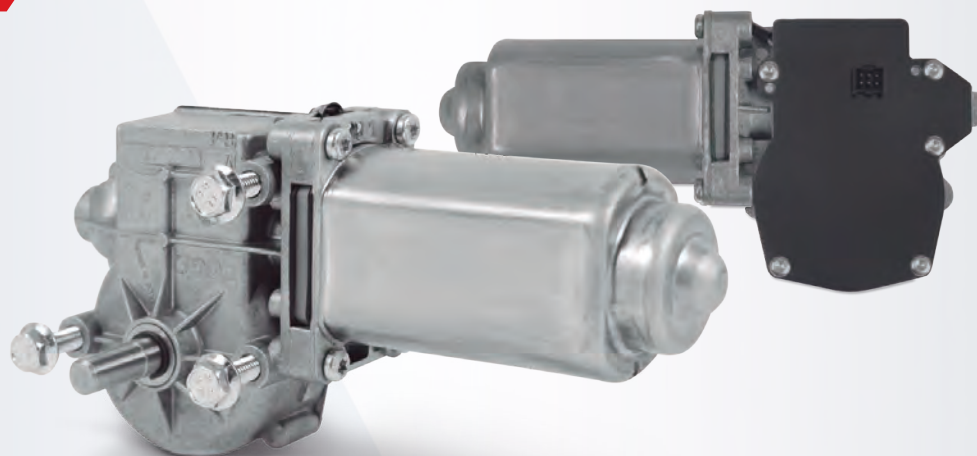

MOTOR FEATURES

REFERENCE NUMBER REFERENCIA REFERENZNUMMERN	NOMINAL VOLTAGE TENSION NOMINALE NENNSPANNUNG	NOMINAL TORQUE PAR NOMINAL COUPLE NOMINAL DREHMOMENT NOMINAL	NOMINAL SPEED VELOCIDAD NOMINAL VITESSE NOMINALE GESCHWINDIGKEIT NOMINAL	NOMINAL CURRENT CORRENTE NOMINAL COURANT NOMINAL NOMINALSTROM	STARTING TORQUE PAR DE ARRANQUE COUPLE DE DEMARRAGE ANZUGSDREHMOMENT	STARTING CURRENT CORRENTE DE ARRANQUE COURANT DE DEMARRAGE ANLAUFSTROM	SHAFT EJE ARBE WELLE	CONNECTIONS CONEXIONES CONNEXIONS ANSCHLUSSART	WIRING DIAGRAM ESQUEMA ELECTRICO SCHEMA ELECTRIQUE SCHALTBILD	TRANSMISSION RATIO RELACION DE REDUCCION RAPPORT DE REDUCTEUR UNTERSETZUNG	APPROXIMATE WEIGHT PESO APROXIMADO POIDS APPROXIMATIF GEWICHT (ca.)	WATER TIGHTNESS GRADO DE ESTANQUEIDAD ETANCHEITE FEUCHTIGKEITSSCHUTZKASSE	WHEEL MATERIAL MATERIAU RUEDA MAT.DES SCHNICKENRADES	CURVA CURVA KURVE	PULSES NUM. Nº PULSOS NUM. PULSES IMPULSZAHL
	Un (V)	Mn (N.m./lbf.in)	nn (r.p.m.)	In (A)	Ma (N.m./lbf.in)	Ia (A)				i	P (kg/lb)	IP			
31697472000	12	1.5 / 13.27	65	6.0	10 / 88.5	22	E30	C30/C44	EE4	62:1	0.90 / 1.98	IP10	PLA	57	310
31697473000	24	1.5 / 13.27	65	3.0	10 / 88.5	11	E30	C30/C44	EE4	62:1	0.90 / 1.98	IP10	PLA	57	310
31697512000	12	2 / 17.70	38	3.4	10 / 88.5	12	E30	C30/C44	EE4	62:1	0.90 / 1.98	IP10	PLA	56	310
31697513000	24	2 / 17.70	38	1.7	10 / 88.5	6	E30	C30/C44	EE4	62:1	0.90 / 1.98	IP10	PLA	56	310

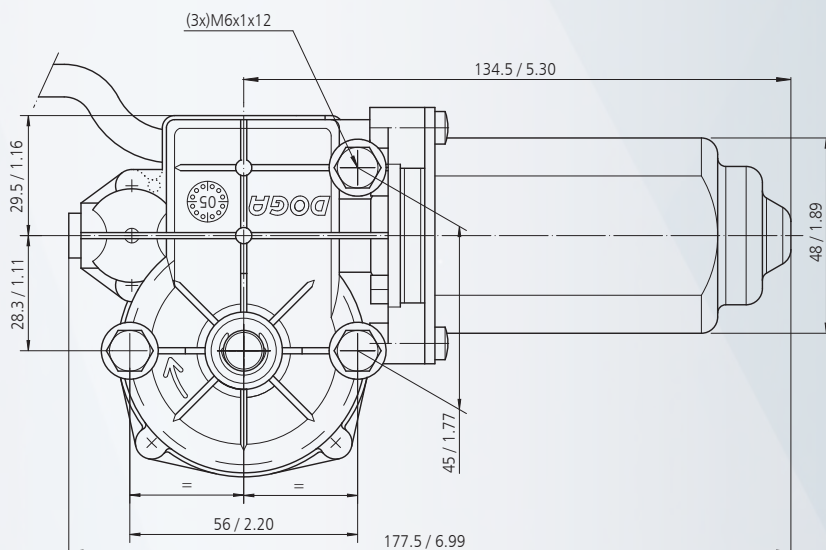
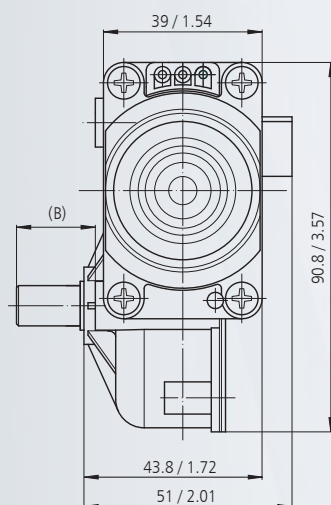

mm / inch

CONNECTIONS **CONEXIONES** CONNEXIONS **ANSCHLUSSART**

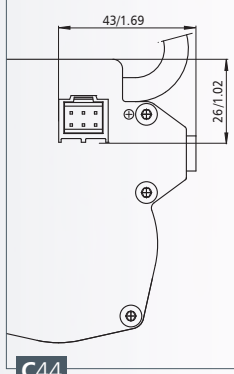
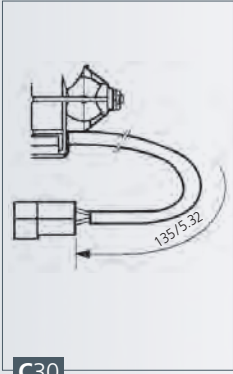

PIN FUNCTION - FUNCIÓN

1	-
2	OUT A
3	OUT B
4	-
5	GND
6	VCC

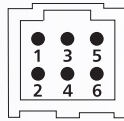

Connector MOLEX 90130-1206 and terminals 90119-2121
 Counter connector (not included) MOLEX 90142-0006

SHAFT **EJE** ARBRE **WELLE**

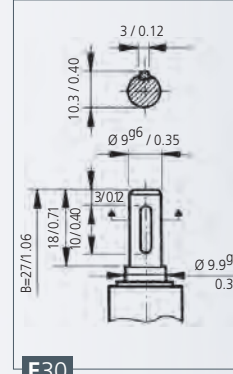

WIRING DIAGRAM **ESQUEMA ELÉCTRICO** SCHÉMA ÉLECTRIQUE **SCHALTBIKD**

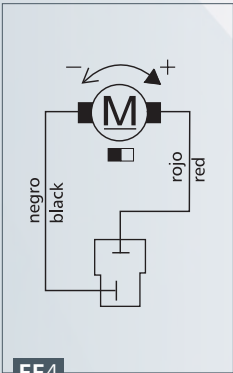

SENSOR HALL **ESQUEMA SENSOR HALL**
SCHÉME SENSOR HALL SCHALTBIKD **HALLSENSOR**

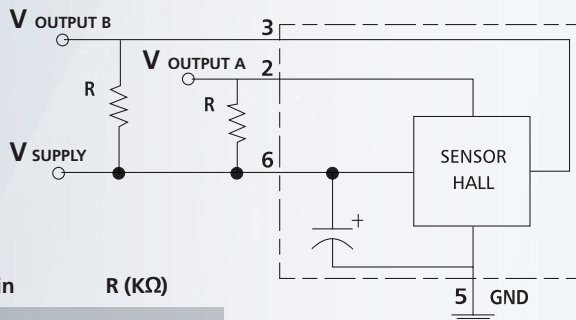

Vout = Vin	R (KΩ)
5V	0.5
12V	1.2
24V	2.4

CURVES **CURVAS** COURBES **KURVEN**

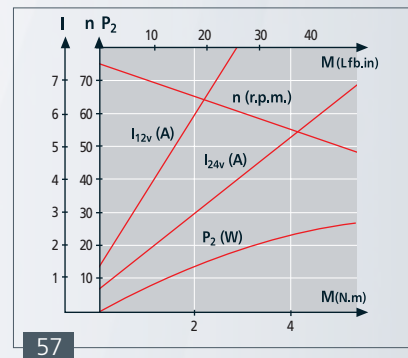
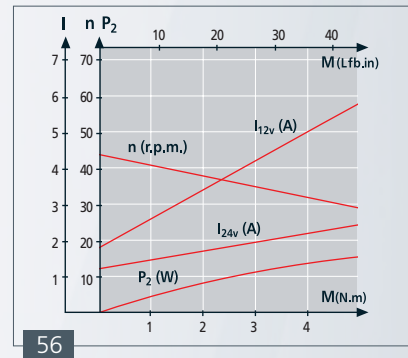

OUTPUT SIGNAL **SEÑAL DE SALIDA**
SIGNALISATION DE SORTIE AUSGANGSSIGNAL

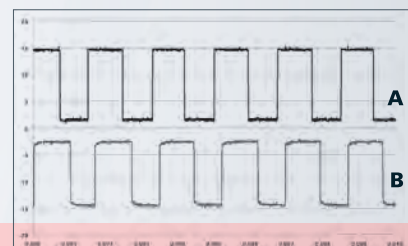

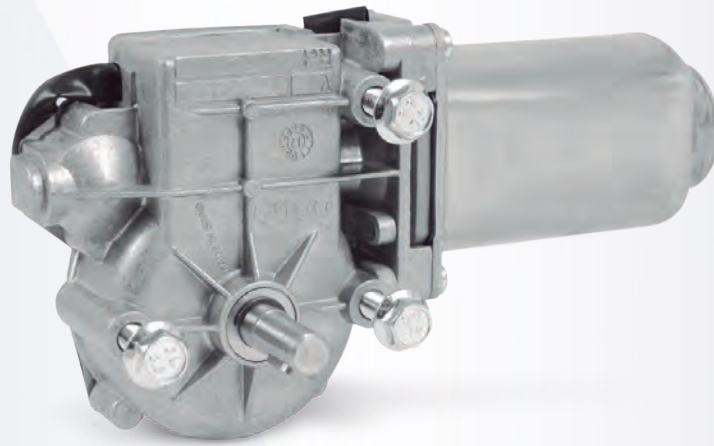

MOTOR FEATURES

REFERENCE NUMBER REFERENCIA REFERENZNUMMERN	NOMINAL VOLTAGE TENSION NOMINAL NENNSPANNUNG	NOMINAL TORQUE PAIR NOMINAL DREHMOMENT NOMINAL	NOMINAL SPEED VELOCIDAD NOMINAL VITESSE NOMINALE GESCHWINDIGKEIT NOMINAL	NOMINAL CURRENT CORRIENTE NOMINAL COURANT NOMINAL NOMINALSTROM	STARTING TORQUE PAIR DE ARRANQUE COUPLE DE DEMARRAGE ANZUGSDREHMOMENT	STARTING CURRENT CORRIENTE DE ARRANQUE COURANT DE DEMARRAGE ANLAUFSTROM	SHAFT EJE ARBRE WELLE	CONNECTIONS CONEXIONES CONNEXIONS ANSCHLUSSART	WIRING DIAGRAM ESQUEMA ELECTRICO SCHEMA ELECTRIQUE SCHALTBILD	TRANSMISSION RATIO RELACION DE REDUCCION RAPPORT DE REDUCTEUR UNTERSETZUNG	APPROXIMATE WEIGHT PESO APROXIMADO POIDS APPROXIMATIF GEWICHT (ca.)	WATER TIGHTNESS GRADO DE ESTANQUEIDAD ETANCHEITE FEUCHTIGKEITSSCHUTZKLASSE	WHEEL MATERIAL MATERIAL RUEDA MATERIAU ROUE MAT. DES SCHNECKENRADES	CURVE CURVA COURBE KURVE
	Un (V)	Mn (N.m./lbf.in)	Fn (r.p.m.)	In (A)	Ma (N.m./lbf.in)	Ia (A)				i	P (kg/lb)	IP		
31727112000	12	4 / 35	25	2.5	12 / 106	8	E22	C30	EE4	62:1	1.15 / 2.54	IP10	PLA	64
31727113000	24	4 / 35	25	1.1	12 / 106	4	E22	C30	EE4	62:1	1.15 / 2.54	IP10	PLA	64
31727612000	12	4 / 35	25	2.5	12 / 106	8	E30	C30	EE4	62:1	1.15 / 2.54	IP10	PLA	64
31727613000	24	4 / 35	25	1.1	12 / 106	4	E30	C30	EE4	62:1	1.15 / 2.54	IP10	PLA	64
31727612000E	12	4 / 35	25	2.5	12 / 106	8	E30	C30	F4	62:1	1.15 / 2.54	IP10	PLA	64
31727613000E	24	4 / 35	25	1.1	12 / 106	4	E30	C30	F4	62:1	1.15 / 2.54	IP10	PLA	64

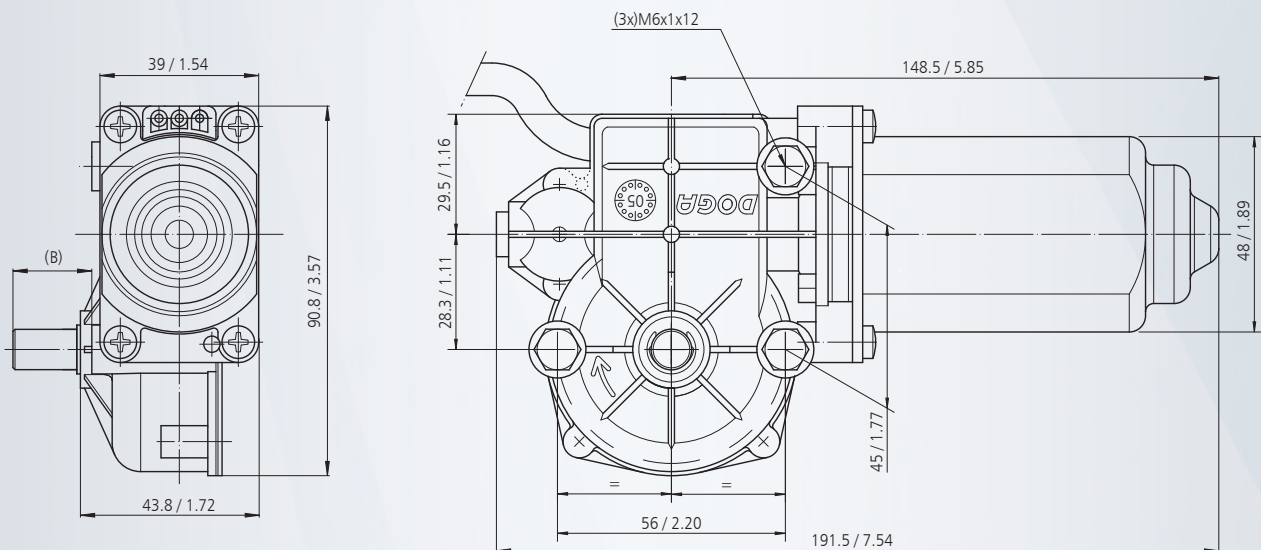

mm / inch

SHAFT EJE ARBRE WELLE

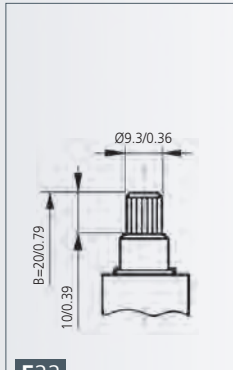

E22

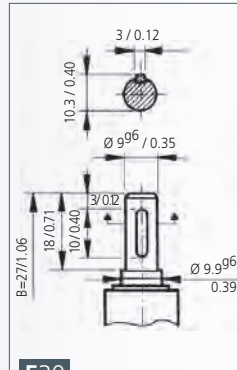

E30

CONNECTIONS **CONEXIONES** CONNEXIONS ANSCHLUSSART

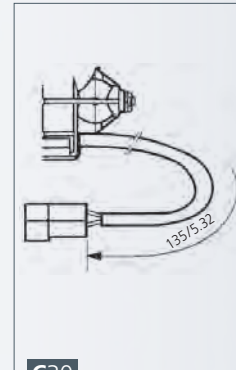

C30

CURVES **CURVAS** COURBES KURVEN

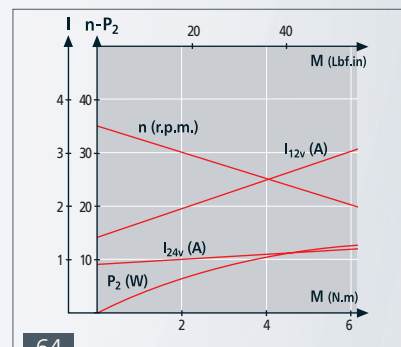

64

WIRING DIAGRAM **ESQUEMA ELÉCTRICO** SCHEMA ÉLECTRIQUE SCHALTBILD

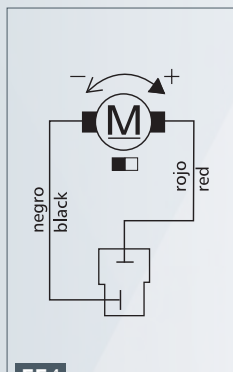

EE4

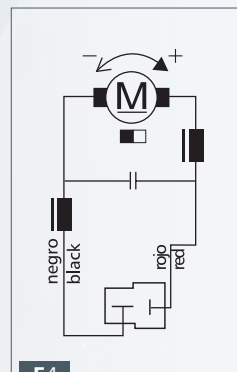

F4

317 hall

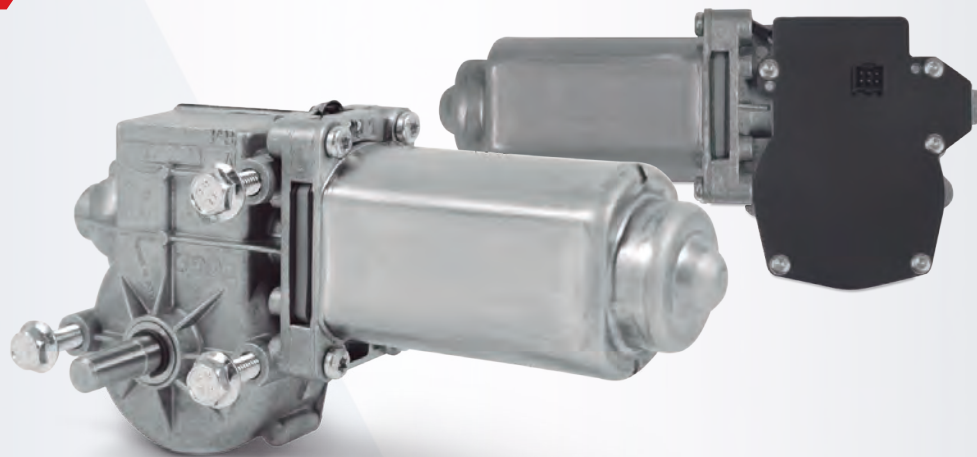

MOTOR FEATURES

REFERENCE NUMBER REFERENCIA REFERENZNUMMERN	NOMINAL VOLTAGE TENSION NOMINALE NENNSPANNUNG	NOMINAL TORQUE PAR NOMINAL COUPLE NOMINAL DREHMOMENT NOMINAL	NOMINAL SPEED VELOCIDAD NOMINAL VITESSE NOMINALE GESCHWINDIGKEIT NOMINAL	NOMINAL CURRENT CORRIENTE NOMINAL COURANT NOMINAL NOMINALSTROM	STARTING TORQUE PAR DE ARRANQUE COUPLE DE DEMARRAGE ANZUGSDREHMOMENT	STARTING CURRENT CORRIENTE DE ARRANQUE COURANT DE DEMARRAGE ANLAUFSTROM	SHAFT EJE ARBE WELLE	CONNECTIONS CONEXIONES CONNEXIONS ANSCHLUSSART	WIRING DIAGRAM ESQUEMA ELECTRICO SCHEMA ELECTRIQUE SCHALTBILD	TRANSMISSION RATIO RELACION DE REDUCCION RAPPORT DE REDUCTEUR UNTERSETZUNG	APPROXIMATE WEIGHT PESO APROXIMADO POIDS APPROXIMATIF GEWICHT (ca.)	WATERTIGHTNESS GRADO DE ESTANQUEIDAD ETANCHEITE FEUCHTIGKEITSSCHUTZKLASSE	WHEEL MATERIAL MATERIAL RUEDA MATERIAL ROUE MATERIAL DES SCHNECKENRADES	CURVE CURVA COURBE KURVE	PULSES NUM. Nº PULSOS NUM. PULSES IMPULSANZAHL
	Un (V)	Mn (N.m./lbf.in)	nn (r.p.m.)	In (A)	Ma (N.m./lbf.in)	Ia (A)				i	P (kg/lb)	IP			
31797062000	12	4 / 35	25	2.5	12 / 106	8	E30	C30/C44	EE4	62:1	1.15/2.54	IP10	PLA	64	310
31797063000	24	4 / 35	25	1.1	12 / 106	4	E30	C30/C44	EE4	62:1	1.15/2.54	IP10	PLA	64	310

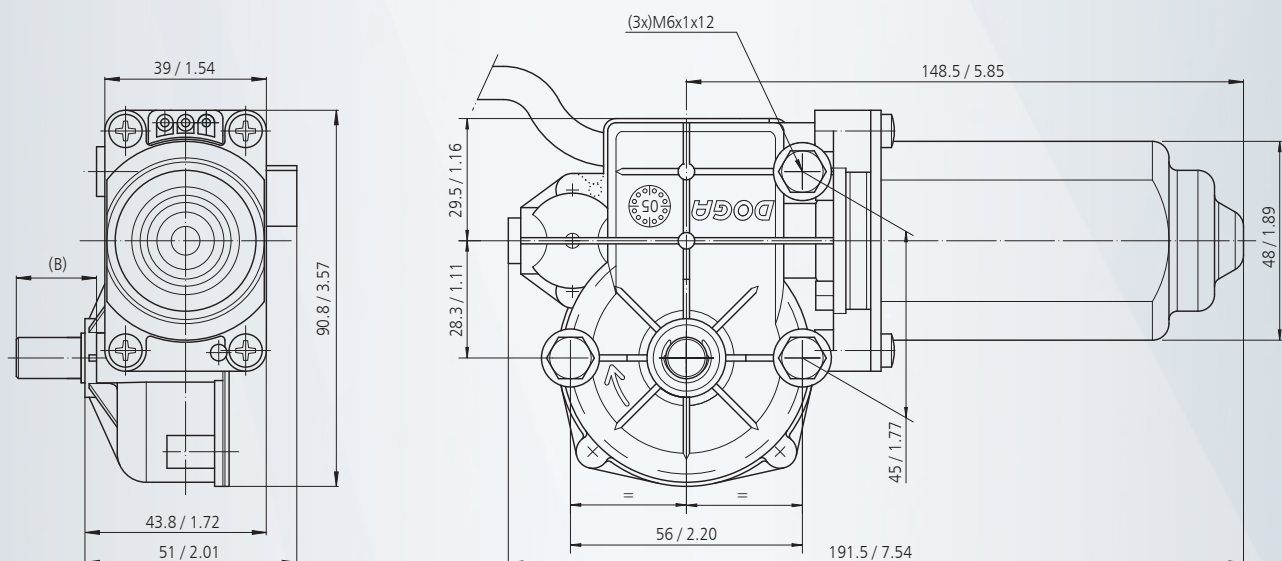

mm / inch

CONNECTIONS **CONEXIONES** CONNEXIONS **ANSCHLUSSART**

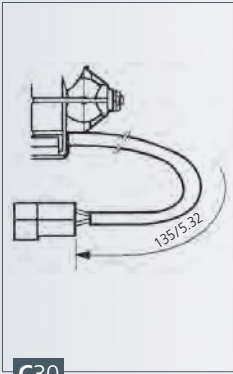

C30

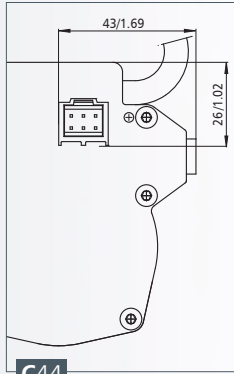

C44

PIN FUNCTION - FUNCIÓN

1	-
2	OUT A
3	OUT B
4	-
5	GND
6	VCC

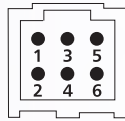

Connector MOLEX 90130-1206 and terminals 90119-2121
 Counter connector (not included) MOLEX 90142-0006

SHAFT **EJE** ARBRE **WELLE**

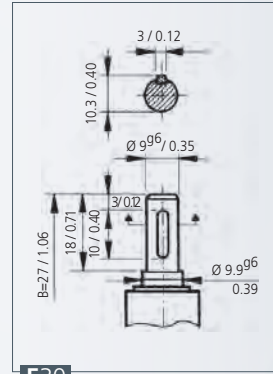

E30

WIRING DIAGRAM **ESQUEMA ELÉCTRICO** SCHEMA ÉLECTRIQUE **SCHALTBILD**

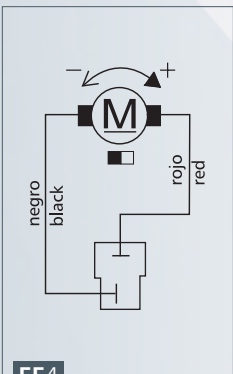

EE4

CURVES **CURVAS** COURBES **KURVEN**

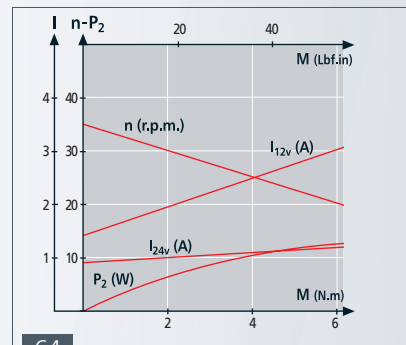

64

SENSOR HALL **ESQUEMA SENSOR HALL**
SCHEMA SENSOR HALL SCHALTBILD HALLSENSOR

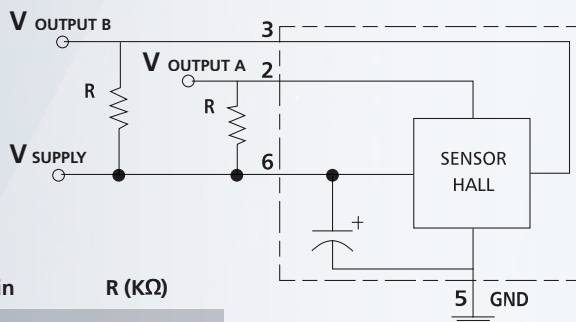

Vout = Vin	R (KΩ)
5V	0.5
12V	1.2
24V	2.4

OUTPUT SIGNAL **SEÑAL SALIDA**
SIGNALISATION DE SORTIE AUSGANGSSIGNAL



319



A

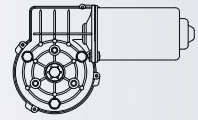

B

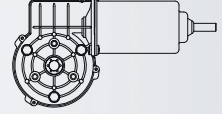

MOTOR FEATURES

REFERENCE NUMBER REFERENCIA REFERENZNUMMERN	NOMINAL VOLTAGE TENSION NOMINALE NENNSPANNUNG	NOMINAL TORQUE PAR NOMINAL DREHMOMENT NOMINAL	NOMINAL SPEED VELOCIDAD NOMINAL VITESSE NOMINALE GESCHWINDIGKEIT NOMINAL	NOMINAL CURRENT CORRENTE NOMINAL COURANT NOMINAL NOMINALSTROM	STARTING TORQUE PAR DE ARRANQUE COUPLE DE DEMARRAGE ANZUGSDREHMOMENT	STARTING CURRENT CORRENTE DE ARRANQUE COURANT DE DEMARRAGE ANLAUFSTROM	SHAFT EJE ARBRE WELLE	CONNECTIONS CONEXIONES CONNEXIONS ANSCHLUSSART	WIRING DIAGRAM ESQUEMA ELECTRICO SCHEMA ELECTRIQUE SCHALTBILD	TRANSMISSION RATIO RELACION DE REDUCCION RAPPORT DE REDUCTEUR UNTERSATZUNG	APPROXIMATE WEIGHT PESO APROXIMADO POIDS APPROXIMATIF GEWICHT (ca.)	WATERTIGHTNESS GRADO DE ESTANQUEIDAD ETANCHÉITÉ FEUCHTIGKEITSSCHUTZKLASSE	WHEEL MATERIAL MATERIAL ROUEA MATERIAL DES SCHNECKENRADES	DESIGN: A, B, C DISEÑO: A, B, C DESSIN: A, B, C	CURVE CURVA COURBE KURVE
	Un (V)	Mn (N.m./lbf.in)	nn (r.p.m.)	In (A)	Ma (N.m./lbf.in)	Ia (A)				i	P (kg/lb)	IP			
31918462000	12	4 / 35	85	7	40 / 354	60	E35	C37	F5	78:2	1.7 / 3.75	IP65	PLA	A	62
31918463000	24	4 / 35	85	3.5	40 / 354	30	E35	C37	F5	78:2	1.7 / 3.75	IP65	PLA	A	62
31918602000	12	9 / 79.6	30	7	50 / 442	28	E35	C37	F5	81:1	1.7 / 3.75	IP65	PLA	A	58
31918603000	24	9 / 79.6	30	3	50 / 442	15	E35	C37	F5	81:1	1.7 / 3.75	IP65	PLA	A	58
31918622000	12	8 / 70.8	45	6	50 / 442	50	E35	C37	F5	81:1	1.7 / 3.75	IP65	PLA	A	60
31918623000	24	9 / 79.6	45	3	60 / 531	25	E35	C37	F5	81:1	1.7 / 3.75	IP65	PLA	A	61
31938202000	12	9 / 79.6	30	7	50 / 442	28	E35	C37	EE4	81:1	1.7 / 3.75	IP65	BRO	A	58
31938203000	24	9 / 79.6	30	3	50 / 442	15	E35	C37	EE4	81:1	1.7 / 3.75	IP65	BRO	A	58
31938222000	12	8 / 70.8	45	6	50 / 442	50	E35	C37	EE4	81:1	1.7 / 3.75	IP65	BRO	A	60
31938223000	24	9 / 79.6	45	3	60 / 531	25	E35	C37	EE4	81:1	1.7 / 3.75	IP65	BRO	A	61
31938452000	12	6 / 53.1	65	8	35 / 309	40	E35	C37	EE4	78:2	1.7 / 3.75	IP65	PLA	A	67
31938453000	24	6 / 53.1	65	4	40 / 354	25	E35	C37	EE4	78:2	1.7 / 3.75	IP65	PLA	A	67
31938462000	12	4 / 35	85	7	40 / 354	60	E35	C37	EE4	78:2	1.7 / 3.75	IP65	PLA	A	62
31938463000	24	4 / 35	85	3.5	40 / 354	30	E35	C37	EE4	78:2	1.7 / 3.75	IP65	PLA	A	62
31938602000	12	9 / 79.6	30	7	50 / 442	28	E35	C37	EE4	81:1	1.7 / 3.75	IP65	PLA	A	58
31938603000	24	9 / 79.6	30	3	50 / 442	15	E35	C37	EE4	81:1	1.7 / 3.75	IP65	PLA	A	58
31938622000	12	8 / 70.8	45	6	50 / 442	50	E35	C37	EE4	81:1	1.7 / 3.75	IP65	PLA	A	60
31938623000	24	9 / 79.6	45	3	60 / 531	25	E35	C37	EE4	81:1	1.7 / 3.75	IP65	PLA	A	61
31990593000	24	2.2 / 19.47	230	4	20 / 177	36	E35	C37	EE4	68:4	1.7 / 3.75	IP65	PLA	A	65
31991283000	24	2.2 / 19.47	230	4	20 / 177	36	E35/E66	C38	EE4	68:4	1.7 / 3.75	IP40	PLA	B	65
31991372000	12	2 / 17.7	155	8	20 / 177	60	E35	C38	EE4	68:4	1.7 / 3.75	IP65	PLA	A	66
31991373000	24	2 / 17.7	175	4	20 / 177	30	E35	C38	EE4	68:4	1.7 / 3.75	IP65	PLA	A	66

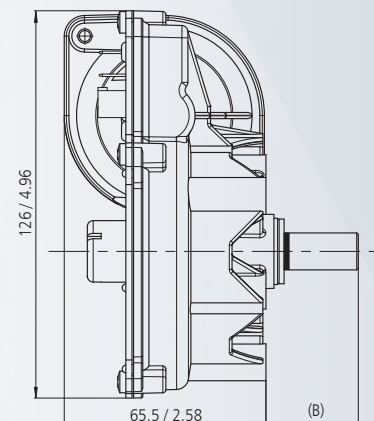
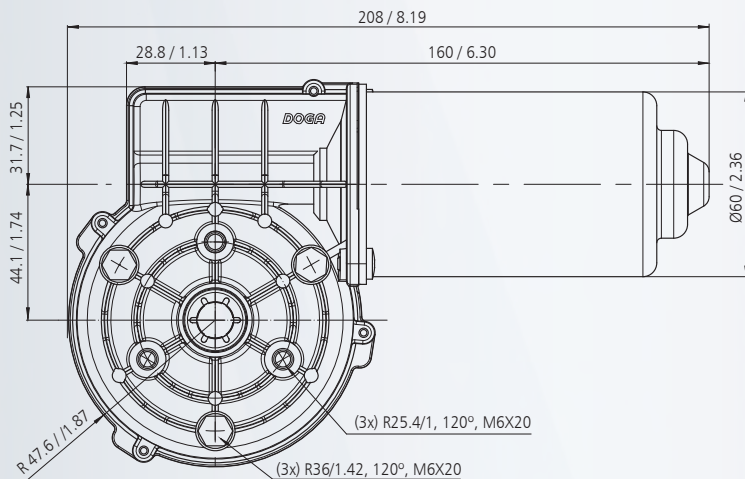

mm / inch

SHAFT EJE ARBRE WELLE

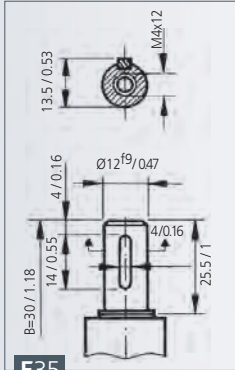

E35

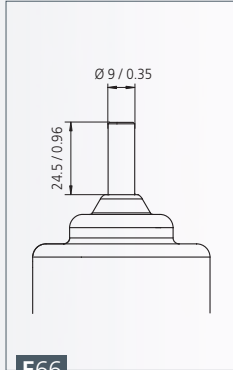

E66

CONEXIONES **CONNECTIONS**
CONNEXIONS ANSCHLUSSART

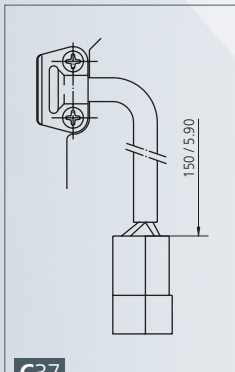

C37

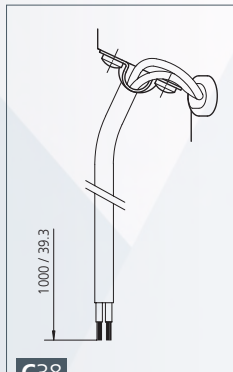

C38

WIRING DIAGRAM **ESQUEMA ELÉCTRICO**
SCHEMA ÉLECTRIQUE SCHALTBILD

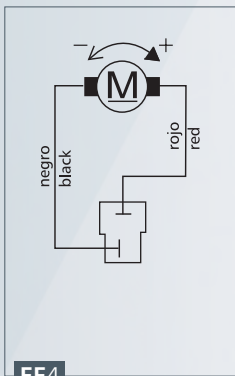

EE4

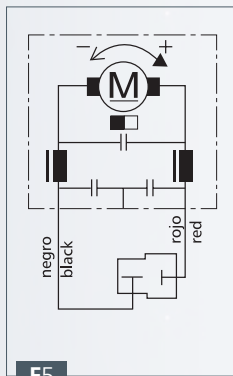

F5

CURVAS **CURVES** COURBES **KURVEN**

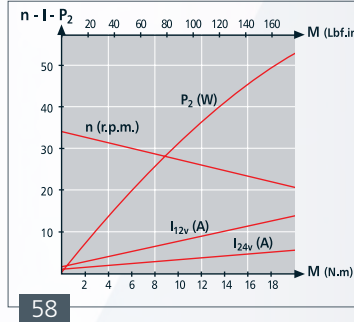

58

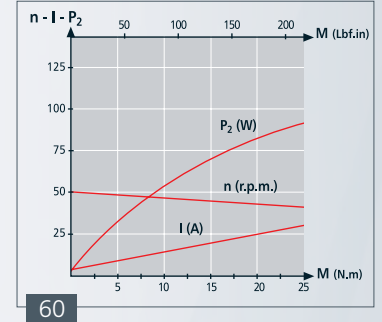

60

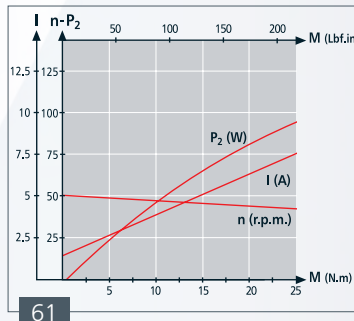

61

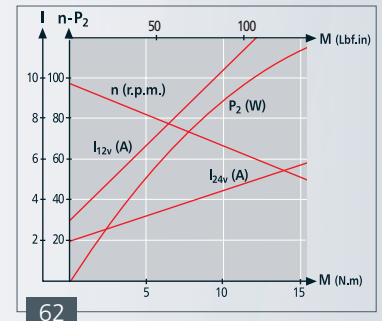

62

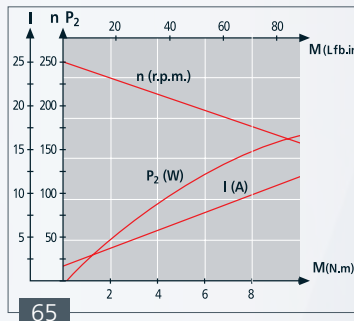

65

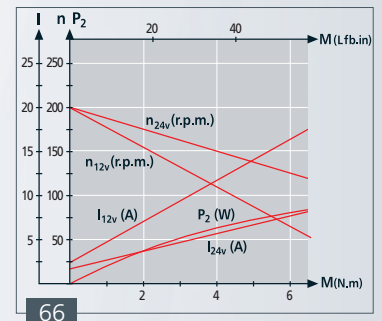

66

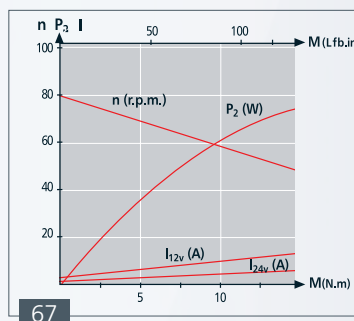

67

319 hall

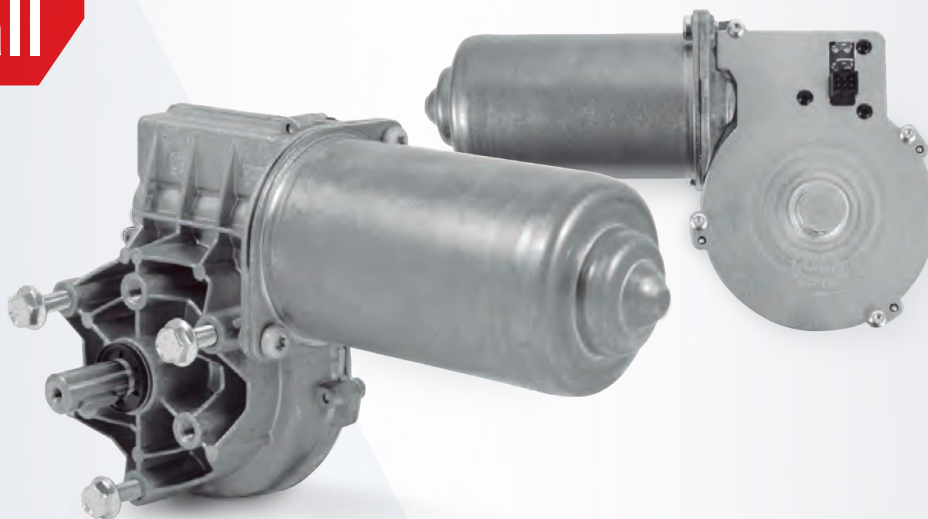

MOTOR FEATURES

REFERENCE NUMBER REFERENCIA REFERENCE REFERENZNUMMERN	NOMINAL VOLTAGE TENSION NOMINALE NENNSPANNUNG	NOMINAL TORQUE PAR NOMINAL COUPLE NOMINAL DREHMOMENT NOMINAL	NOMINAL SPEED VELOCIDAD NOMINAL VITESSE NOMINALE GESCHWINDIGKEIT NOMINAL	NOMINAL CURRENT CORRIENTE NOMINAL COURANT NOMINAL NOMINALSTROM	STARTING TORQUE PAR DE ARRANQUE COUPLE DE DEMARRAGE ANZUGSDREHMOMENT	STARTING CURRENT CORRIENTE DE ARRANQUE COURANT DE DEMARRAGE ANLAUFSTROM	SHAFT EJE ARBRE WELLE	CONNECTIONS CONEXIONES CONNEXIONS ANSCHLUSSART	WIRING DIAGRAM ESQUEMA ELECTRICO SCHEMA ELECTRIQUE	TRANSMISSION RATIO RELACION DE REDUCCION RAPPORT DE REDUCTEUR UNTERSETZUNG	APPROXIMATE WEIGHT PESO APROXIMADO POIDS APPROXIMATIF GEWICHT (GR.)	WATERTIGHTNESS GRADO DE ESTANQUEIDAD ETANCHEITE FEUCHTIGKEITSSCHUTZKLASSE	WHEEL MATERIAL MATERIAL RUEDA MATERIAU ROUE MAT. DES SCHNICKENRADES	CURVE CURVA COURBE KURVE	PULSES NUM. NO. PULSOS NUM. POISES IMPULSANZAHL
	Un (V)	Mn (N.m./lbf.in)	nn (r.p.m.)	In (A)	Ma (N.m./lbf.in)	Ia (A)				i	P (kg/lb)	IP			
31948462000	12	4 / 35	85	6	40 / 354	60	E35	C45	F6	78:2	1.7 / 3.75	IP40	PLA	62	468
31948463000	24	4 / 35	85	3	40 / 354	30	E35	C45	F6	78:2	1.7 / 3.75	IP40	PLA	62	468
31948602000	12	9 / 79.6	30	7	50 / 442	28	E35	C45	F6	81:1	1.7 / 3.75	IP40	PLA	58	972
31948603000	24	9 / 79.6	30	3	50 / 442	15	E35	C45	F6	81:1	1.7 / 3.75	IP40	PLA	58	972
31948622000	12	8 / 70.8	45	6	50 / 442	50	E35	C45	F6	81:1	1.7 / 3.75	IP40	PLA	60	972
31948623000	24	9 / 79.6	45	3	60 / 531	25	E35	C45	F6	81:1	1.7 / 3.75	IP40	PLA	61	972

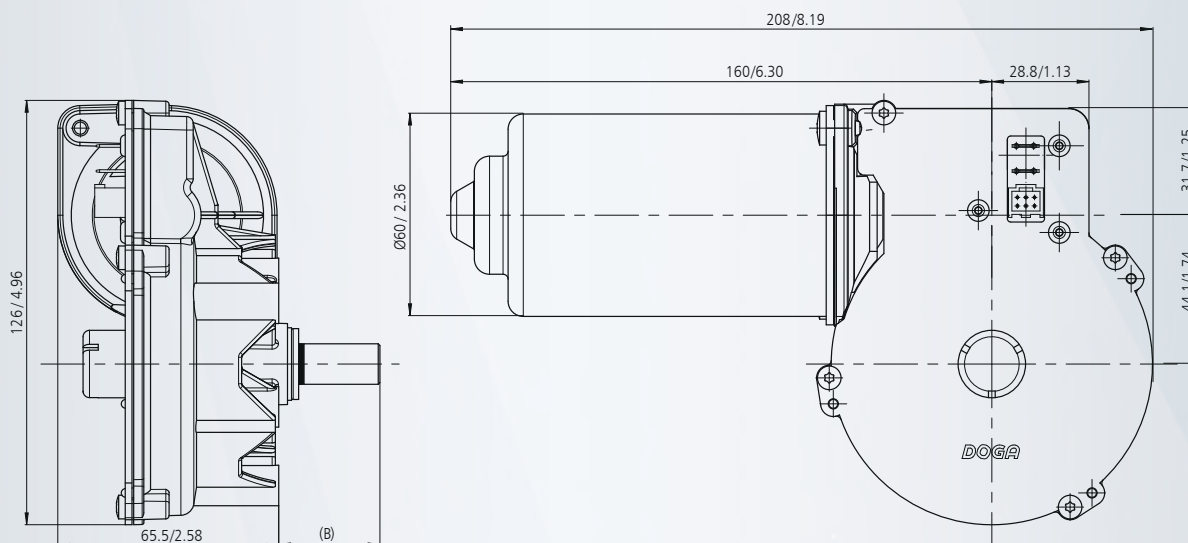

mm / inch

CONNECTIONS **CONEXIONES** CONNEXIONS **ANSCHLUSSART**

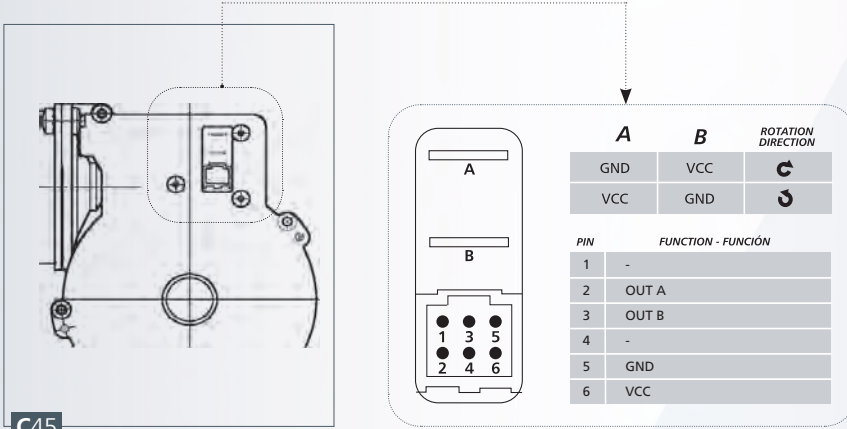

C45

SHAFT **EJE** ARBRE **WELLE**

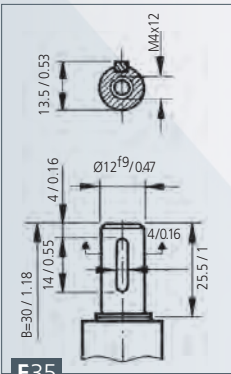

E35

WIRING DIAGRAM **ESQUEMA ELÉCTRICO**
 SCHÉMA ÉLECTRIQUE **SCHALTBIKD**

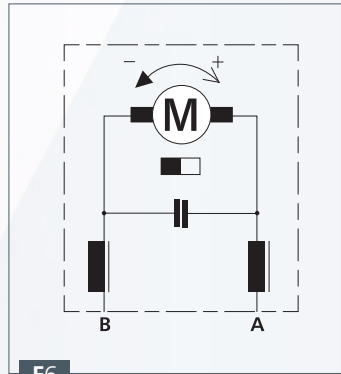

F6

OUTPUT SIGNAL **SEÑAL SALIDA**
 SIGNALISATION DE SORTIE **AUSGANGSSIGNAL**

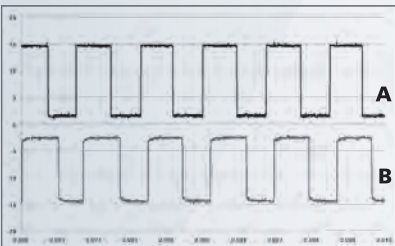

SENSOR HALL **ESQUEMA SENSOR HALL**
 SCHÉME SENSOR HALL **SCHALTBIKD HALLSENSOR**

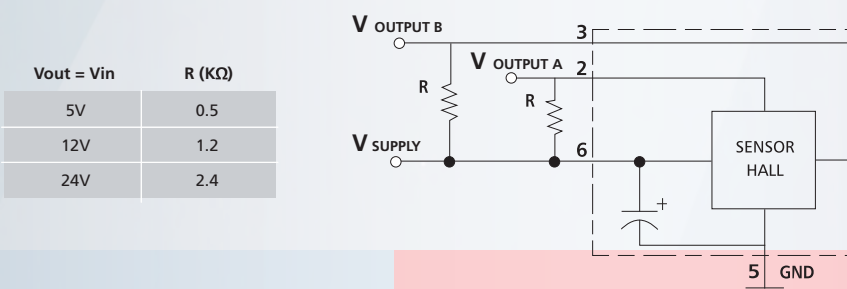

CURVES **CURVAS** COURBES **KURVEN**

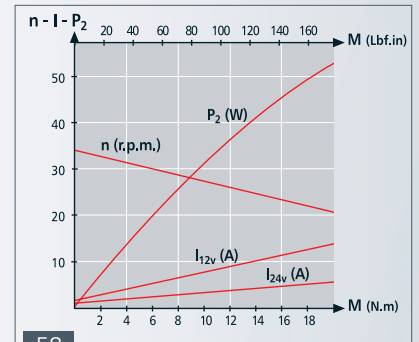

58

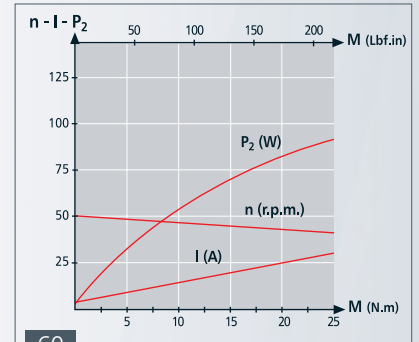

60

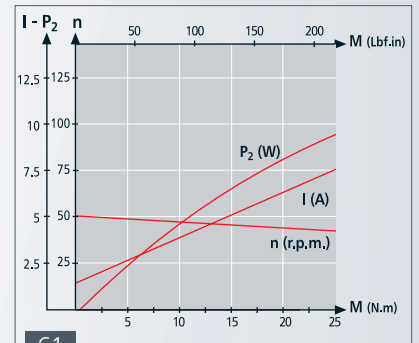

61

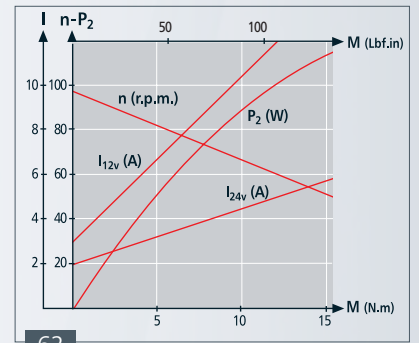

62

359

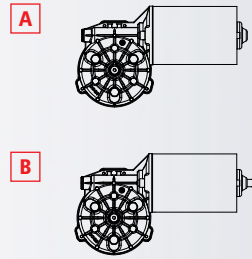
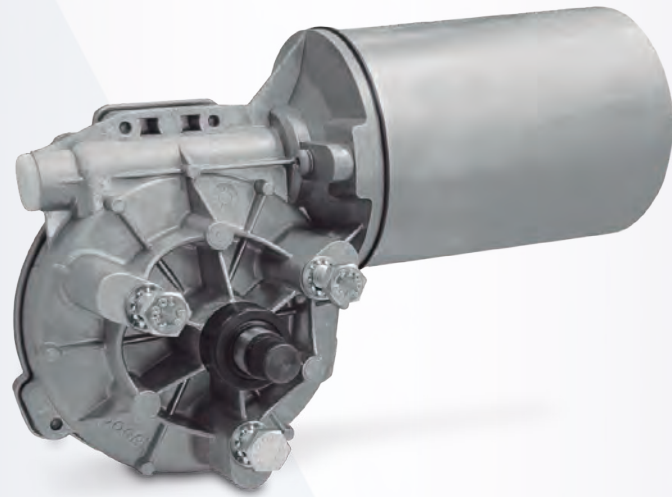

MOTOR FEATURES

REFERENCE NUMBER REFERENCIA REFERENZNUMMERN	NOMINAL VOLTAGE TENSION NOMINALE NENNSPANNUNG	NOMINAL TORQUE PAR NOMINAL DREHMOMENT NOMINAL	NOMINAL SPEED VELOCIDAD NOMINAL VITESSE NOMINALE GESCHWINDIGKEIT NOMINAL	NOMINAL CURRENT CORRIENTE NOMINAL COURANT NOMINAL NOMINALS FROM	STARTING TORQUE PAR DE ARRANQUE COUPLE DE DEMARRAGE ANZUGSDREHMOMENT	STARTING CURRENT CORRIENTE DE ARRANQUE COURANT DE DEMARRAGE ANLAUFSTROM	SHAFT EJE ARBRE WELLE	CONNECTIONS CONEXIONES CONNEXIONS ANSCHLUSSART	WIRING DIAGRAM ESQUEMA ELECTRICO SCHEMA ELECTRIQUE SCHALTBLD.	TRANSMISSION RATIO RELACION DE REDUCCION RAPPORT DE REDUCTEUR UNTERSEITUNG	APPROXIMATE WEIGHT PESO APROXIMADO POIDS APPROXIMATIF GEWICHT (ca)	WATERTIGHTNESS GRADO DE ESTANQUEIDAD ETANCHÉITÉ FEUCHTIGKEITSSCHUTZKLASSE	WHEEL MATERIAL MATERIAL RUEDA MATERIAL ROUE MATERIAL DES SCHNITTENRÄDES	DESIGN: A-B DISEÑO: A-B DESSIN: A-B ABBILDUNG: A-B	CURVE CURVA COURBE KURVE
	Un (V)	Mn (N.m./lbf.in)	Pn (r.p.m.)	In (A)	Ma (N.m./lbf.in)	Ia (A)				i	P (kg/lb)	IP			
35937102000	12	20 / 177	22	13.8	130 / 1150	60	E37	C47	EE20	50:1	5.90 / 13	IP 66	PLA	A	20
35937103000	24	20 / 177	22	6	130 / 1150	30	E37	C47	EE20	50:1	5.90 / 13	IP 66	PLA	A	20
35992992000	12	15 / 132.7	40	18	120 / 1062	98	E37	C47	F20	50:1	5.90 / 13	IP 66	PLA	A	21
35992993000	24	15 / 132.7	40	9	120 / 1062	49	E37	C47	F20	50:1	5.90 / 13	IP 66	PLA	A	21
35990423000	24	25 / 221	25	7	135 / 1195	30	E37 / E51	C47	F20	50:1	5.90 / 13	IP 40	PLA	B	22

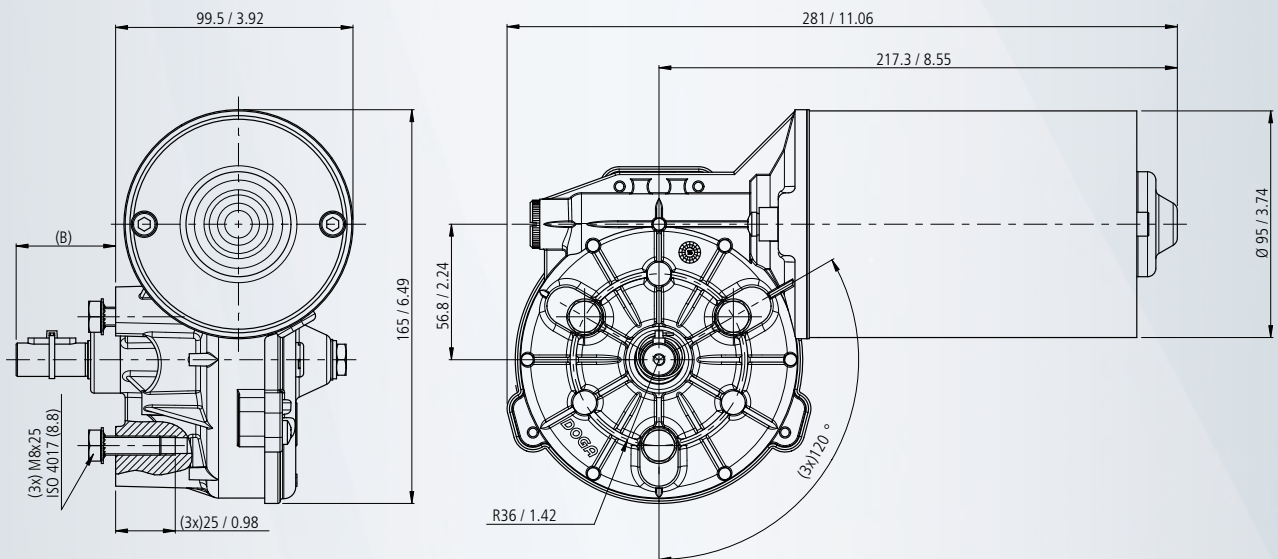

mm / inch

SHAFT **EJE** ARBRE **WELLE**

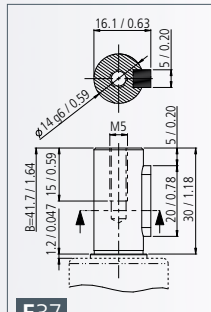

E37

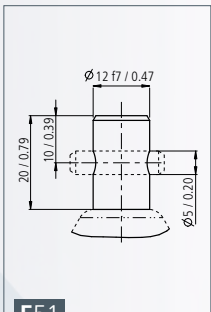

E51

WIRING DIAGRAM **ESQUEMA ELÉCTRICO** SCHEMA ÉLECTRIQUE **SCHALTBILD**

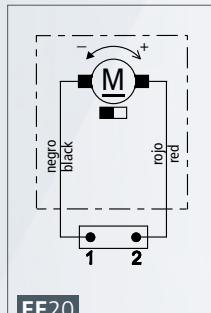

EE20

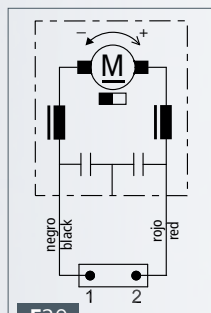

F20

CONNECTIONS **CONEXIONES** CONNEXIONS **ANSCHLUSSART**



C47

mating conector (not supplied)
 TE/DEUTSCH DT06-2S

CURVES **CURVAS** COURBES **KURVEN**

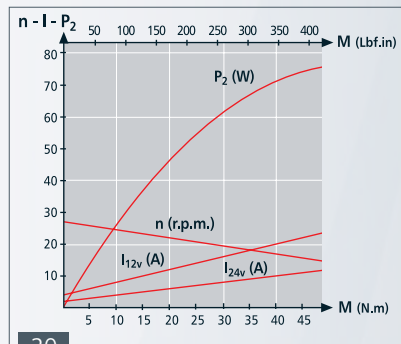

20

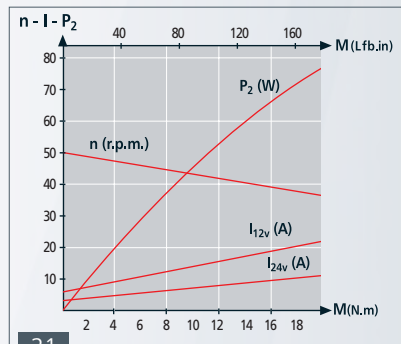

21

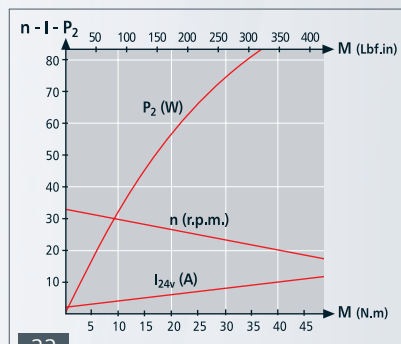

22



STANDARD, CUSTOMIZED
& SPECIAL PROJECTS

ELECTRONIC MOTORS

DOGA

MOTORES ELECTRÓNICOS
MOTEURS ÉLECTRONIQUES
ELEKTRONISCHE MOTOREN

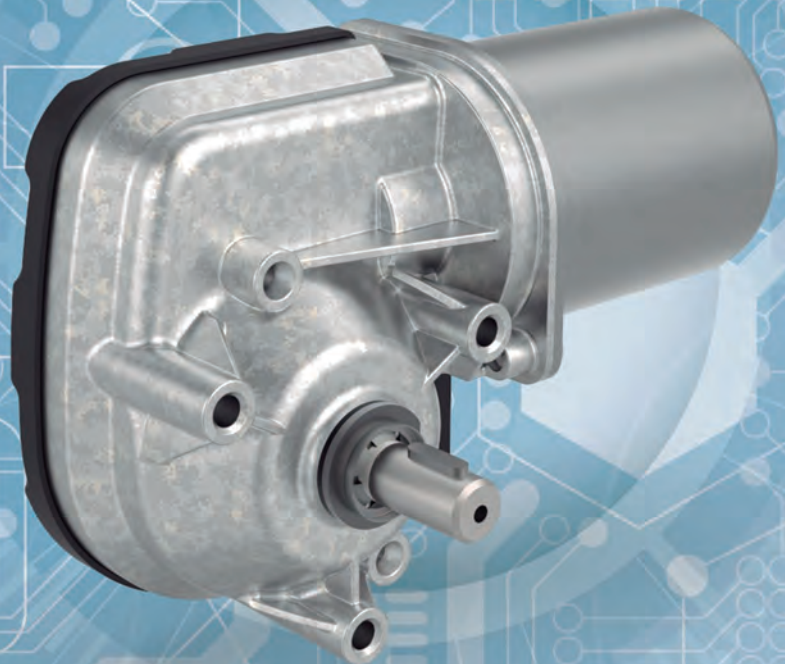

DOGA has designed embedded ECU (Electronic Control Unit) for the gearmotor series 311 and 319, which makes it possible for our customers, in a very compact and robust motor with a contained cost, to have a close loop control on each application.

This concept has already been implemented in series production, in several projects, and can be implemented in particular projects by developing a specific software. Additionally, DOGA offers standard part numbers.

FEATURES AND OPTIONS

- ⇒ CANopen
- ⇒ CAN J1939
- ⇒ LIN
- ⇒ DIGITAL I/O
- ⇒ Combined CAN & DIGITAL I/O (available soon)
- ⇒ Compact motor with integrated driver
- ⇒ IP69K
- ⇒ Voltage system customization: 12 or 24V
- ⇒ Very accurate speed and position control
- ⇒ Smooth motion during reversal of the rotation
- ⇒ Capability to rotate the motor in both senses
- ⇒ Synchronization of several motors
- ⇒ Protections
- ⇒ Parametrization
- ⇒ Diagnostic function
- ⇒ Bootloader
- ⇒ And customizations in 12V and 24V version with different speed, torque performance and output shaft.

At DOGA, we design our motors to perfectly fit in any project.

INTERFACES

Digital inputs/outputs | LIN | CAN J1939 | CANopen

ONE MOTOR FOR EACH APPLICATION.

DOGA a conçu embarqué ECU (Unité de Commande Électronique) pour les séries 311 et 319 qui permet aux clients d'un contrôle de boucle fermée dans chaque application sur un moteur très compact et robuste avec un coût contenu.

Ce concept a déjà été mis en place dans plusieurs projets, maintenant en production de séries, et peut être implémenté dans certains projets en mettant au point un logiciel dédié. De plus, DOGA propose des références standard.

CARACTÉRISTIQUES ET OPTIONS

- ⇒ CANopen
- ⇒ CAN J1939
- ⇒ LIN
- ⇒ DIGITAL I/O
- ⇒ CAN & DIGITAL I/O combinés (bientôt disponible)
- ⇒ Moteur compacte avec unité de commande électronique intégré
- ⇒ IP69K
- ⇒ Personnalisation de système en tension : 12 ou 24V
- ⇒ Contrôle de la vitesse et position très précise
- ⇒ Mouvement souple au cours de l'inversion de la rotation
- ⇒ Capacité pour faire tourner le moteur dans les deux sens
- ⇒ Synchronisation de plusieurs moteurs
- ⇒ Protections
- ⇒ Paramétrage
- ⇒ Fonction diagnostique
- ⇒ Bootloader
- ⇒ Et personnalisations en version 12V ou 24V avec différentes vitesses, performances de couple et arbre de sortie.

Chez DOGA, nous personnalisons pour s'adapter parfaitement à tout projet.

INTERFACES

Entrées numériques | LIN | CAN J1939 | CANopen

UN MOTEUR POUR CHAQUE APPLICATION.

DOGA ha diseñado una ECU embebida (Unidad de Control Electrónico) para las series de motores 311 y 319, la cual permite a los clientes, en un motor compacto, robusto y de coste contenido, lograr un control en lazo cerrado de cada aplicación.

Este concepto está ya implementado en varios proyectos, actualmente en producción, y puede ser implementado en proyectos particulares desarrollando un software específico. En DOGA también disponemos de referencias estándar.

CARACTERÍSTICAS Y OPCIONES

- ⇒ CANopen
- ⇒ CAN J1939
- ⇒ LIN
- ⇒ DIGITAL I/O
- ⇒ CAN & DIGITAL I/O combinados (disponible en breve)
- ⇒ Motor compacto con controlador integrado
- ⇒ IP69K
- ⇒ Voltaje adaptable: 12 o 24V
- ⇒ Control exacto de velocidad y posición.
- ⇒ Suave movimiento en inversión de giro
- ⇒ Capacidad de rotación del motor en ambos sentidos
- ⇒ Sincronización de varios motores
- ⇒ Protecciones
- ⇒ Parametrización
- ⇒ Función de diagnóstico
- ⇒ Bootloader
- ⇒ Motores a medida en 12V o 24V con distintas velocidades, rendimiento de par y ejes de salida.

En DOGA diseñamos motores para que encajen a la perfección en cualquier proyecto.

INTERFACES

Digital inputs/outputs | LIN | CAN J1939 | CANopen

UN MOTOR PARA CADA APLICACIÓN.

Für die Motorbaureihen 311 sowie 319 hat DOGA eine eingebettete ECU entwickelt. Die Kombination ermöglicht kostengünstige Anwendungen in sich geschlossener Systeme, in kompakter und robuster Bauform.

DOGA fertigt diesen Motor bereits für verschiedenste Kundenanwendungen in Serienproduktion. Anwendungen können nach kundenspezifischen Anforderungen entwickelt werden.

FUNKTIONEN UND OPTIONEN

- ⇒ CANopen
- ⇒ CAN J1939
- ⇒ LIN
- ⇒ DIGITAL I/O
- ⇒ Kombiniert CAN und DIGITAL I/O (in Kürze erhältlich)
- ⇒ Kompakter Motor mit integrierter Steuerung
- ⇒ IP69K
- ⇒ Nennspannung : 12 oder 24V
- ⇒ Sehr exakte Geschwindigkeitssteuerung
- ⇒ Ruckfreie Bewegung bei Drehrichtungsänderung
- ⇒ Reversierbetrieb
- ⇒ Synchronisation von mehreren Motoren
- ⇒ Motorschutz
- ⇒ Parametrisierung
- ⇒ Diagnosefunktion
- ⇒ Bootloader
- ⇒ Kundenspezifische Anpassungen der 12V- und 24V-Motoren durch unterschiedliche Drehzahl, Drehmoment und Abtriebswelle

DOGA Motoren können spezifisch auf Kundenprojekte appliziert werden um eine perfekte Integration zu ermöglichen.

SCHNITTSTELLEN

Digitale Eingänge | LIN | CAN J1939 | CANopen

EIN MOTOR FÜR JEDWEDE ANWENDUNG!

311E



MOTOR FEATURES

REFERENCE NUMBER REFERENCIA REFERENZNUMMERN	NOMINAL VOLTAGE TENSION NOMINALE NENNSPANNUNG	NOMINAL TORQUE PAR NOMINAL DREHMOMENT NOMINAL	NOMINAL SPEED VELOCIDAD NOMINAL VITESSE NOMINALE GESCHWINDIGKEIT NOMINAL	NOMINAL CURRENT CORRIENTE NOMINAL COURANT NOMINAL NOMINALSTROM	STARTING TORQUE PAR DE ARRANQUE COUPLE DE DÉMARRAGE ANZUGSDREHMOMENT	STARTING CURRENT CORRIENTE DE ARRANQUE COURANT DE DÉMARRAGE ANLAUFSTROM	SHAFT EJE ARBRE WELLE	CONNECTIONS CONEXIONES CONNEXIONS ANSCHLUSSART	WIRING DIAGRAM ESQUEMA ELECTRICO SCHEMA ELECTRIQUE SCHALTBIID	TRANSMISSION RATIO RELACION DE REDUCCION RAPPORT DE REDUCTEUR UNTERSEITZUNG	APPROXIMATE WEIGHT PESO APROXIMADO POIDS APPROXIMATIF GEWICHT (ca.)	WATERTIGHTNESS GRADO DE ESTANQUEIDAD ETANCHEITE FEUCHTIGKEITSSCHUTZKLASSE	WHEEL MATERIAL MATERIAU RUEDA MAT. DES SCHNECKENRADES	CURVE CURVA COURBE KURVE
	Un (V)	Mn (N.m./lbf.in)	n _n (r.p.m.)	In (A)	Ma (N.m./lbf.in)	Ia (A)				i	P (kg/lb)	IP		
311E4033000	24	6 / 53.1	50	2.8	18 / 159.3	10	E69	C48	F19	76:1	1.2 / 2.76	IP69K	PLA	83
311E4143000	24	4 / 35	63	2.7	14 / 123.9	10	E69	C48	F19	76:1	1.2 / 2.76	IP69K	PLA	84

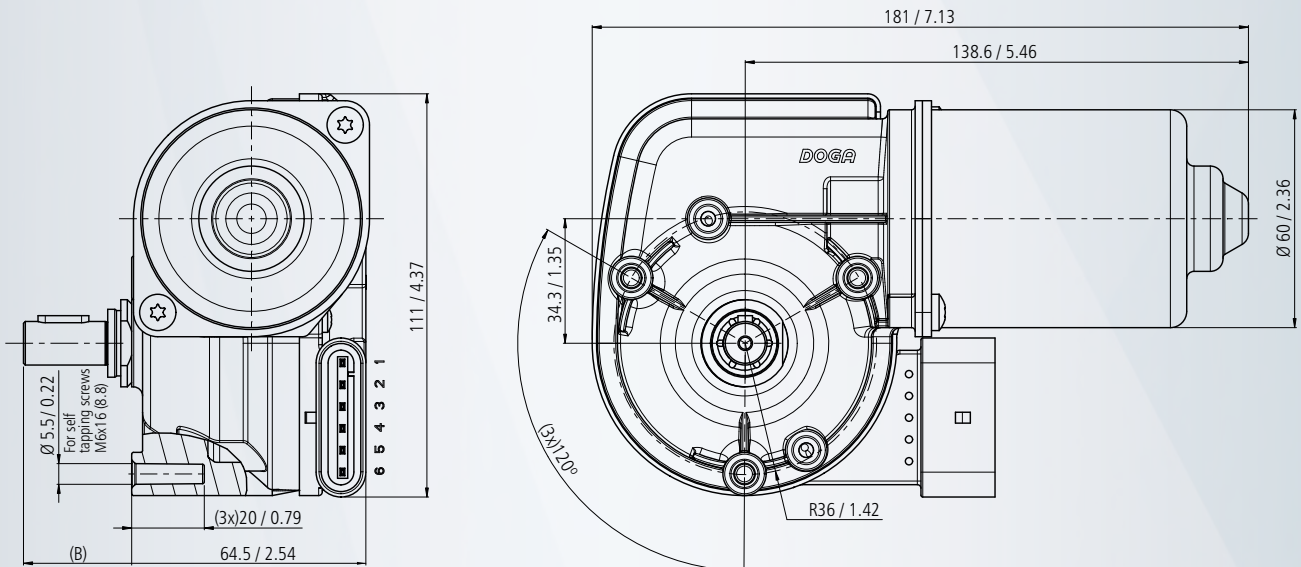

mm / inch

ELECTRONIC MOTORS MOTORES ELECTRÓNICOS **311E**
 MOTEURS ÉLECTRONIQUES ELEKTRONISCHE MOTOREN

MOTOR FEATURES

COMMUNICATION COMUNICACIÓN COMMUNICATION KOMMUNIKATION	⇒ CANopen • CiA 301 • CiA 402 (speed & position)	PROTECTIONS PROTECCIONES PROTECTIONS MOTORENSCHUTZ	⇒ BLOCKING ⇒ OVERLOAD ⇒ OVERVOLTAGE ⇒ UNDERVOLTAGE
SPEED CONTROL CONTROL DE VELOCIDAD CONTRÔLE DE VITESSE GESCHWINDIGKEITSREGELUNG		BOOTLOADER	
POSITION CONTROL CONTROL DE POSICIÓN CONTRÔLE DE POSITION POSITIONSREGELUNG		DIAGNOSTIC FUNCTION FUNCIÓN DE DIAGNOSIS FONCTION DIAGNOSTIQUE DIAGNOSEFUNKTION	⇒ UDS (not DTC)

SHAFT EJE ARBRE WELLE

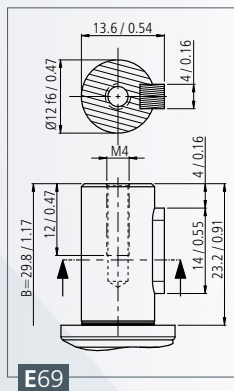

E69

CONNECTIONS CONEXIONES CONNEXIONS ANSCHLUSSART

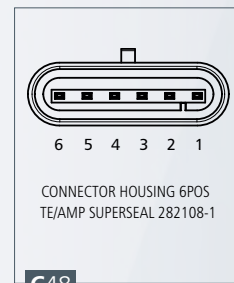

C48

Mating housing 6POS (not supplied)
TE/AMP Superseal 282090-1

WIRING DIAGRAM ESQUEMA ELÉCTRICO SCHEMA ÉLECTRIQUE SCHALTBILD

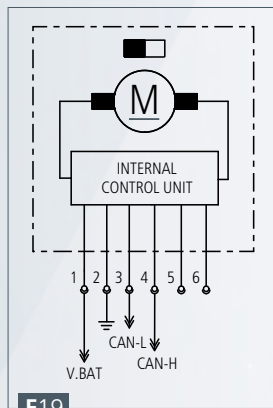

F19

CURVES CURVAS COURBES KURVEN

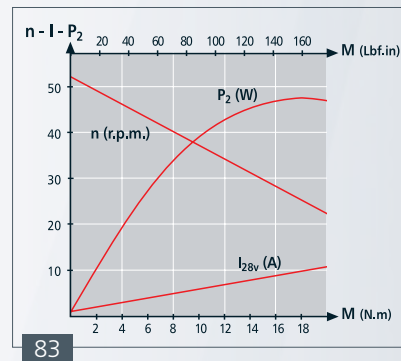

83

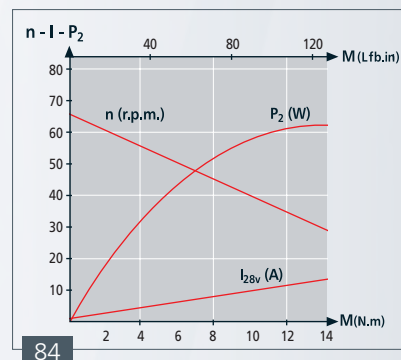

84

311E

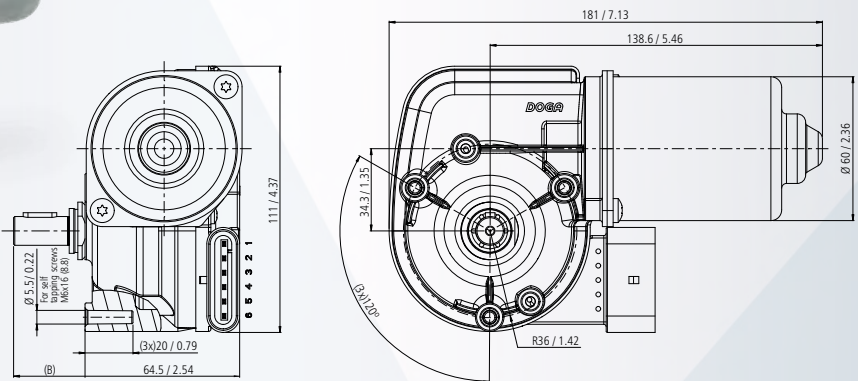
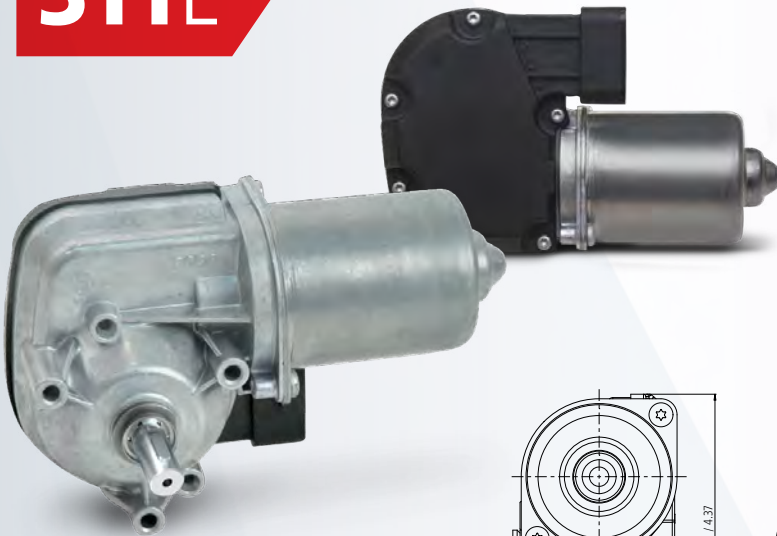

319E

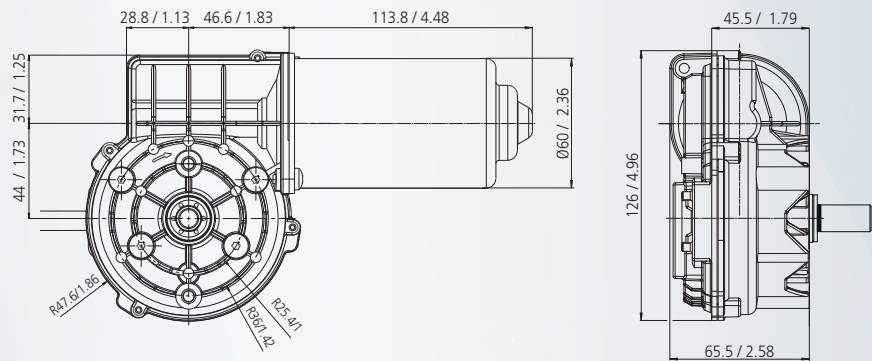
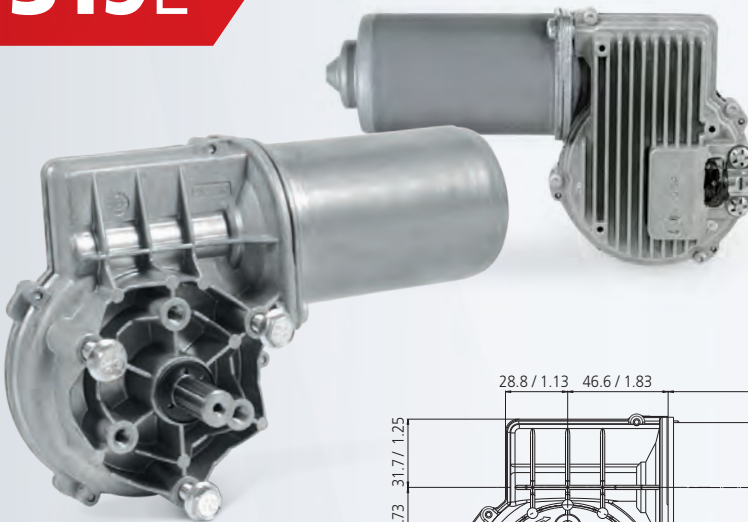



STANDARD, CUSTOMIZED
& SPECIAL PROJECTS

DC MOTORS

DOGA

MOTORES CC
MOTEURS À CC
GLEICHSTROMMOTOREN



- **PLANETARY GEAR option:**
See special section in catalogue.
- **REDUCTOR PLANETARIO opcional:**
Ver sección especial en catálogo.
- **RÉDUCTEUR PLANÉTAIRE en option:**
Consultez section spécial du catalogue.
- **Optionales PLANETENGETRIEBE:**
Sehen Sie Sonderabschnitt im Katalog.

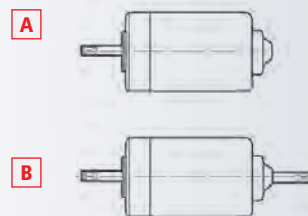

MOTOR FEATURES

REFERENCE NUMBER REFERENCIA REFERENZNUMMERN	NOMINAL VOLTAGE TENSION NOMINAL TENSION NOMINALE NENNSPANNUNG	NOMINAL TORQUE PAR NOMINAL COUPLE NOMINAL DREHMOMENT NOMINAL	NOMINAL SPEED VELOCIDAD NOMINAL VITESSE NOMINALE GESCHWINDIGKEIT NOMINAL	NOMINAL CURRENT CORRIENTE NOMINAL COURANT NOMINAL NOMINALSTROM	STARTING TORQUE PAR DE ARRANQUE COUPLE DE DÉMARRAGE ANZUGSDREHMOMENT	STARTING CURRENT CORRIENTE DE ARRANQUE COURANT DE DÉMARRAGE ANLAUFSTROM	SHAFT EJE ARBRE WELLE	CONNECTIONS CONEXIONES CONNEXIONS ANSCHLÜSSART	WIRING DIAGRAM ESQUEMA ELECTRICO SCHEMA ELECTRIQUE SCHALTBILD	APPROXIMATE WEIGHT PESO APROXIMADO POIDS APPROXIMATIF GEWICHT (ca.)	WATERTIGHTNESS GRADO DE ESTANQUEIDAD ÉTANCHÉITÉ FEUCHTIGKEITSSCHUTZKLASSE	DESIGN: A/B DISEÑO: A/B DESSIN: A/B ABBILDUNG: A/B	CURVE CURVA COURBE KURVE
	Un (V)	Mn (N.m./lbf.in)	Pn (r.p.m.)	In (A)	Ma (N.m./lbf.in)	Ia (A)				P (kg/lb)	IP		
16241012000	12	0.18 / 1.59	2800	7.5	1.0 / 8.85	33	E2	C2	EE2	1.1 / 2.43	IP53	A	32
16241013000	24	0.20 / 1.77	3000	4	1.0 / 8.85	18	E2	C2	EE2	1.1 / 2.43	IP53	A	33
16241022000	12	0.20 / 1.77	2000	6	1.0 / 8.85	24	E2	C3	EE2	1.1 / 2.43	IP53	A	34
16241023000	24	0.20 / 1.77	2000	3	1.0 / 8.85	12	E2	C3	EE2	1.1 / 2.43	IP53	A	34
16241062000	12	0.18 / 1.59	2800	7.5	1.0 / 8.85	33	E4	C2	EE2	1.1 / 2.43	IP53	A	32
16241063000	24	0.20 / 1.77	3000	4	1.0 / 8.85	18	E4	C2	EE2	1.1 / 2.43	IP53	A	33
16241073000E	24	0.20 / 1.77	2000	3	1.0 / 8.85	12	E5	C5	F3	1.1 / 2.43	IP53	A	34
16241082000	12	0.18 / 1.59	1500	5	0.8 / 7.08	17	E2	C3	EE2	1.1 / 2.43	IP53	A	35
16241083000	24	0.18 / 1.59	1500	2.5	0.8 / 7.08	8.5	E2	C3	EE2	1.1 / 2.43	IP53	A	35
16241093000	24	0.18 / 1.59	1500	2.5	0.8 / 7.08	8.5	E38	C35	EE3	1.1 / 2.43	IP53	A	35
16241095000	48	0.18 / 1.59	1500	1,3	0.8 / 7.08	4,5	E38	C35	EE3	1.1 / 2.43	IP53	A	35
16241163000	24	0.20 / 1.77	3000	4	1.0 / 8.85	18	E58/E57	C2	EE2	1.1 / 2.43	IP40	B	33

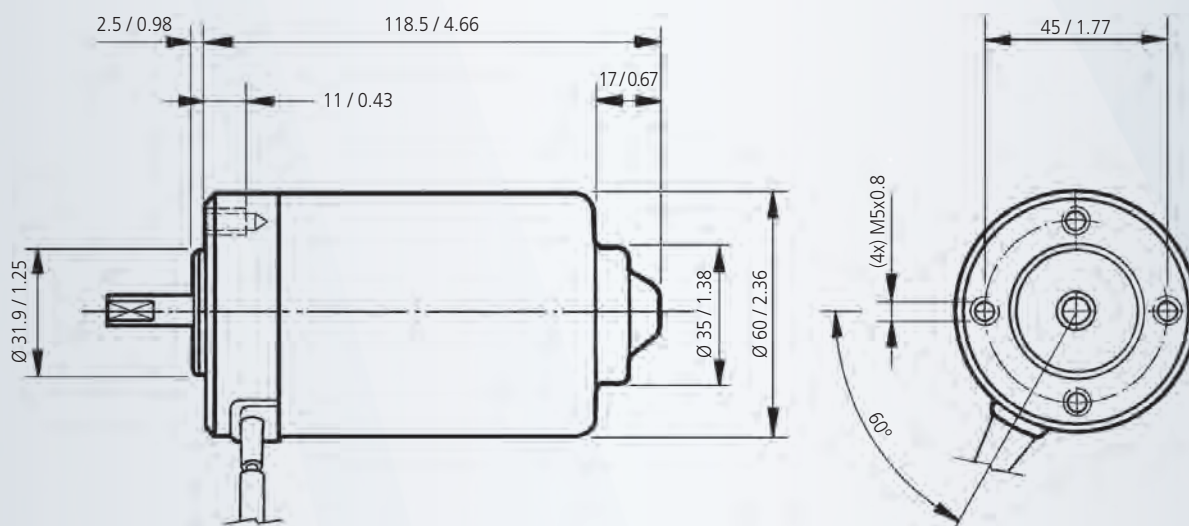

mm / inch

SHAFT EJE ARBRE WELLE

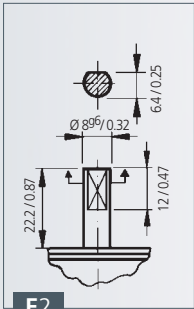

E2

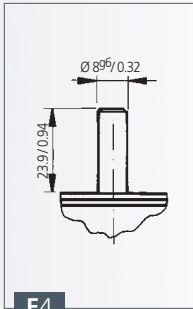

E4

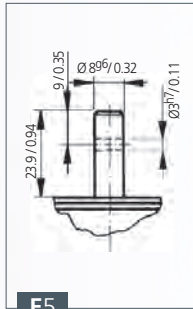

E5

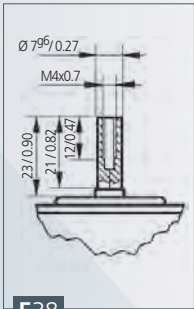

E38

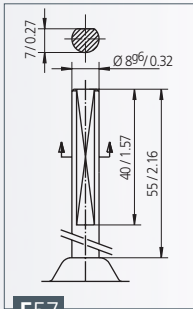

E57

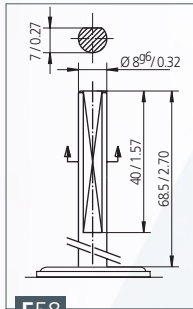

E58

CONNECTIONS CONEXIONES
CONNEXIONS ANSCHLUSSART

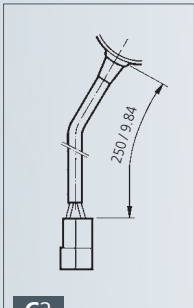

C2

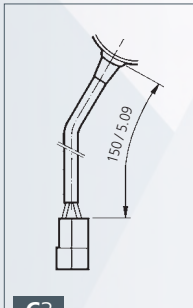

C3

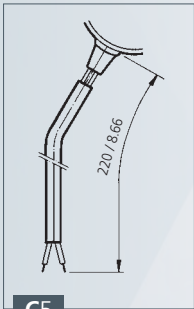

C5

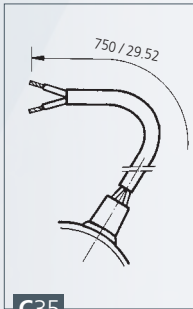

C35

WIRING DIAGRAM ESQUEMA ELÉCTRICO
SCHEMA ÉLECTRIQUE SCHALTBILD

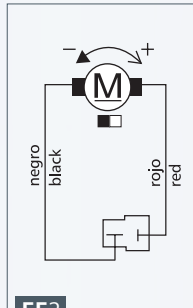

EE2

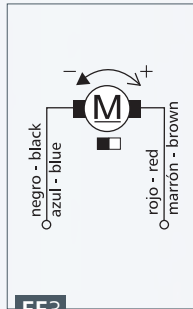

EE3

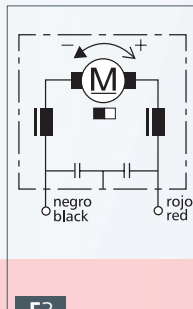

F3

CURVES CURVAS COURBES KURVEN

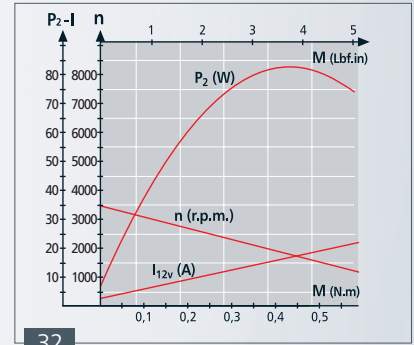

32

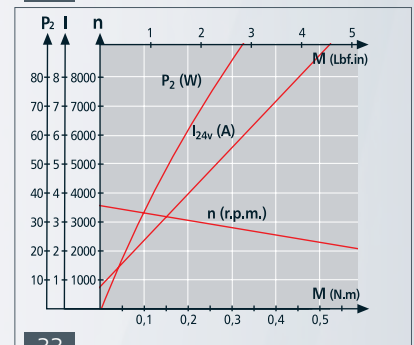

33

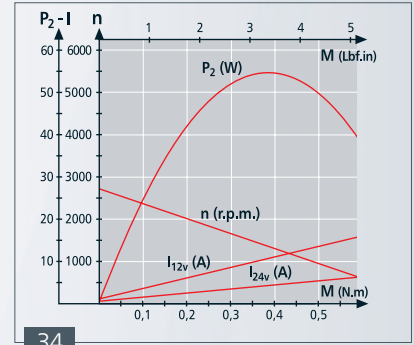

34

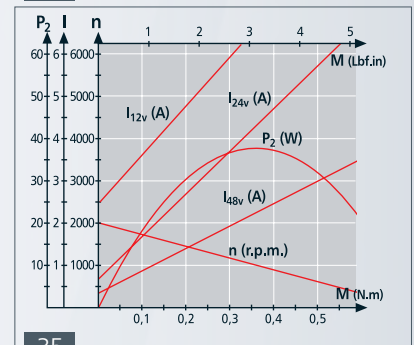

35

- **PLANETARY GEAR option:**
See special section in catalogue.
- **REDUCTOR PLANETARIO opcional:**
Ver sección especial en catálogo.
- **RÉDUCTEUR PLANÉTAIRE en option:**
Consultez section spécial du catalogue.
- **Optionales PLANETENGETRIEBE:**
Sehen Sie Sonderabschnitt im Katalog.

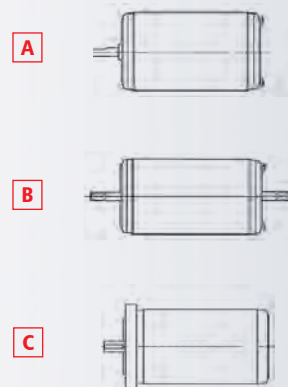

MOTOR FEATURES

REFERENCE NUMBER REFERENCIA REFERENZNUMMERN	NOMINAL VOLTAGE TENSION NOMINAL TENSION NOMINALE NENNSPANNUNG	NOMINAL TORQUE PAR NOMINAL COUPLE NOMINAL DREHMOMENT NOMINAL	NOMINAL SPEED VELOCIDAD NOMINAL VITESSE NOMINALE GESCHWINDIGKEIT NOMINAL	NOMINAL CURRENT CORRIENTE NOMINAL COURANT NOMINAL NOMINALSTROM	STARTING TORQUE PAR DE ARRANQUE COUPLE DE DÉMARRAGE ANZUGSDREHMOMENT	STARTING CURRENT CORRIENTE DE ARRANQUE COURANT DE DÉMARRAGE ANLAUFSTROM	SHAFT EJE ARBRE WELLE	CONNECTIONS CONEXIONES CONNEXIONS ANSCHLUSSART	WIRING DIAGRAM ESQUEMA ELECTRICO SCHEMA ELECTRIQUE SCHALTBILD	APPROXIMATE WEIGHT PESO APROXIMADO POIDS APPROXIMATIF GEWICHT (ca.)	WATER TIGHTNESS GRADO DE ESTANQUEIDAD ÉTANCHÉITÉ FEUCHTIGKEITSSCHUTZKASSE	DESIGN: A, B, C DISEÑO: A, B, C DESSIN: A, B, C ABBILDUNG: A, B, C	CURVE CURVA COURBE KURVE
	Un (V)	Mn (N.m./lb.f.in)	Pn (r.p.m.)	In (A)	Ma (N.m./lb.f.in)	Ia (A)				P (kg/lb)	IP		
16841052004	12	0.50 / 4.42	1900	14	3.0 / 26.5	64	E8	C8	EE1	2.6 / 5.73	IP40	A	37
16841053004	24	0.50 / 4.42	1900	7	3.0 / 26.5	32	E8	C8	EE1	2.6 / 5.73	IP40	A	37
16841082004	12	0.45 / 3.98	2800	19	3.0 / 26.5	100	E9	C9	EE4	2.6 / 5.73	IP40	A	39
16841083004	24	0.45 / 3.98	2800	10	3.0 / 26.5	52	E9	C9	EE4	2.6 / 5.73	IP40	A	39
16841112004	12	0.75 / 6.64	1000	11	2.8 / 24.8	36	E11	C9	EE2	2.6 / 5.73	IP40	A	40
16841113004	24	0.75 / 6.64	1000	5.5	2.8 / 24.8	18	E11	C9	EE2	2.6 / 5.73	IP40	A	40
16841122004	12	0.70 / 6.19	1500	14	3.0 / 26.5	56	E12	C11	EE2	2.6 / 5.73	IP40	A	42
16841123004	24	0.70 / 6.19	1500	7	3.0 / 26.5	28	E12	C11	EE2	2.6 / 5.73	IP40	A	42
16841153004	24	0.50 / 4.42	3000	11	3.0 / 26.5	70	E13/E41	C13	EE2	2.6 / 5.73	IP40	A	41
16841213004E	24	0.50 / 4.42	3000	11	3.0 / 26.5	70	E11/E11	C13	F2	2.6 / 5.73	IP40	B	41
16841223004	24	0.75 / 6.64	1000	5.5	2.8 / 24.8	18	E13/E41	C13	EE2	2.6 / 5.73	IP40	A	40
16841232004	12	0.50 / 4.42	2100	16	3.0 / 26.5	76	E13/E41	C13	EE2	2.6 / 5.73	IP40	A	43
16841233004	24	0.50 / 4.42	2100	8	3.0 / 26.5	38	E13/E41	C13	EE2	2.6 / 5.73	IP40	A	43
16841343004	24	0.30 / 2.65	750	1.5	1.5 / 13.3	7	E59	C9	EE2	2.6 / 5.73	IP40	A	44
16841363000E	24	0.75 / 6.64	1000	5.5	2.8 / 24.8	18	E63	C42	F2	2.6 / 5.73	IP40	C	40

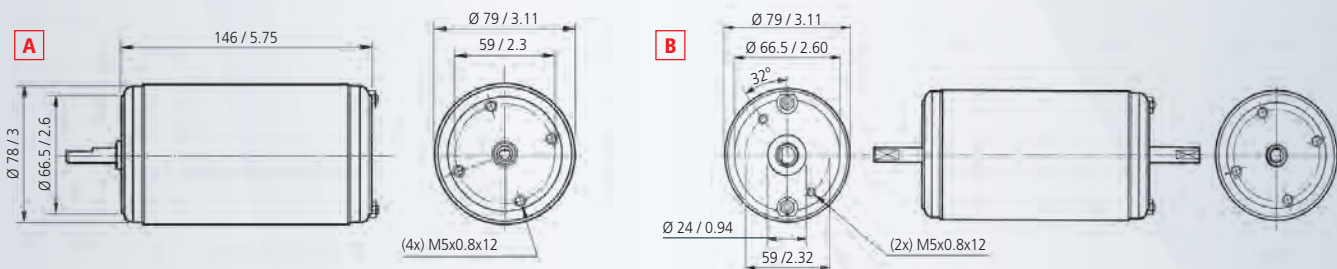

C Flange according to IEC 63 B14 - Puntos de anclaje según IEC 63 B14

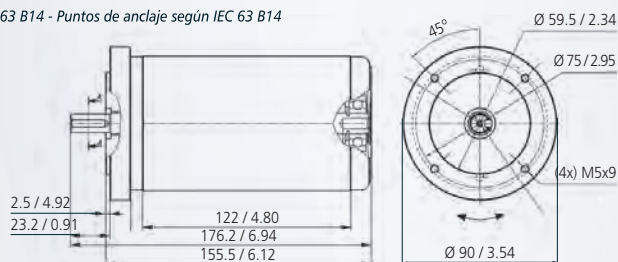

SHAFT EJE ARBRE WELLE

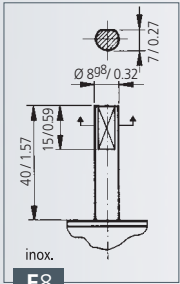

E8

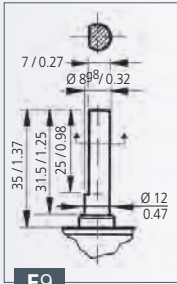

E9

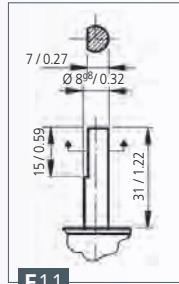

E11

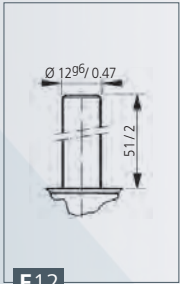

E12

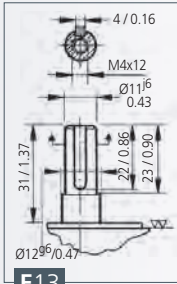

E13

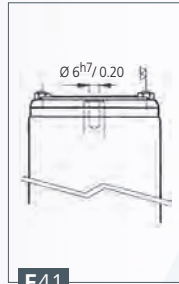

E41

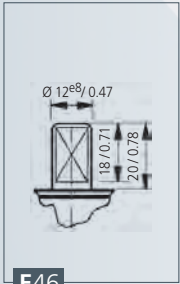

E46

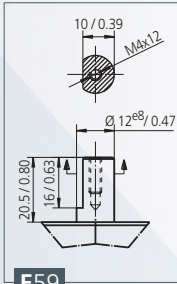

E59

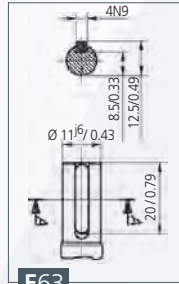

E63

CONNECTIONS CONEXIONES
CONNEXIONS ANSCHLUSSART

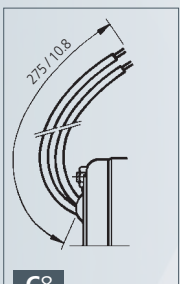

C8

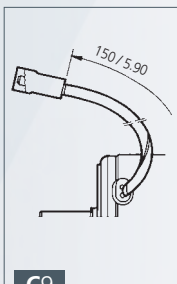

C9

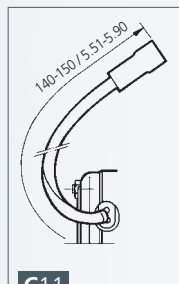

C11

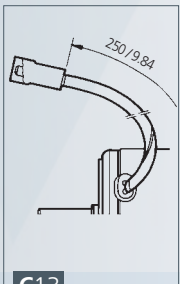

C13

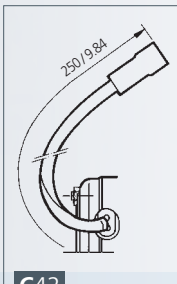

C42

WIRING DIAGRAM ESQUEMA ELÉCTRICO
SCHÉMA ÉLECTRIQUE SCHALTBILD

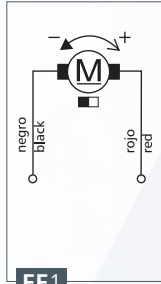

EE1

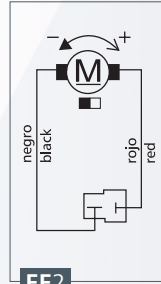

EE2

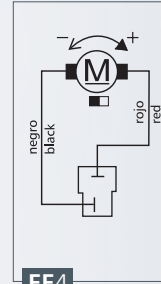

EE4

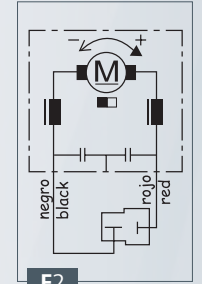

F2

CURVES CURVAS COURBES KURVEN

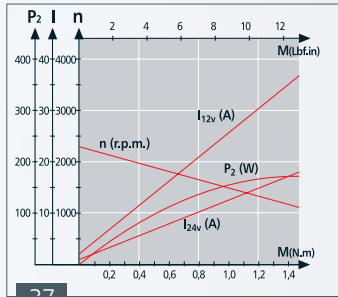

37

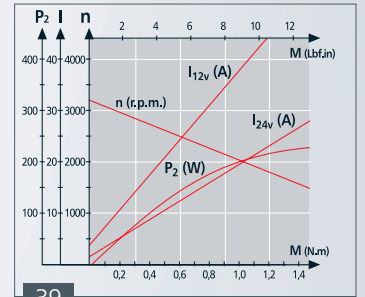

39

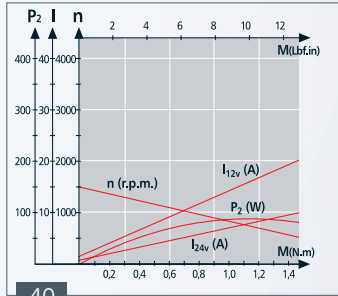

40

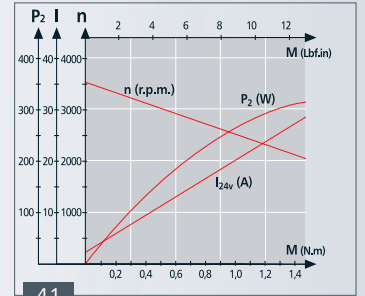

41

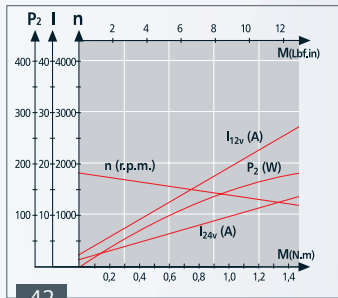

42

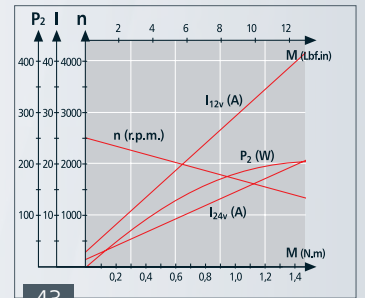

43

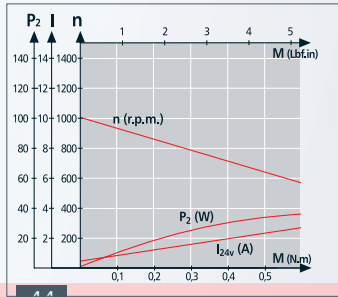

44

- **PLANETARY GEAR option:**
See special section in catalogue.
- **REDUCTOR PLANETARIO opcional:**
Ver sección especial en catálogo.
- **RÉDUCTEUR PLANÉTAIRE en option:**
Consultez section spécial du catalogue.
- **Optionales PLANETENGETRIEBE:**
Sehen Sie Sonderabschnitt im Katalog.

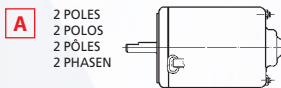
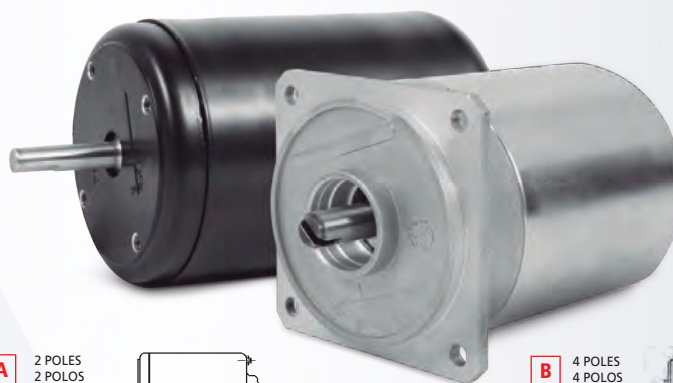

MOTOR FEATURES

REFERENCE NUMBER REFERENCIA REFERENZNUMMERN	NOMINAL VOLTAGE TENSION NOMINALE TENSION NOMINALE NENNSPANNUNG	NOMINAL TORQUE PAR NOMINAL COUPLE NOMINAL DREHMOMENT NOMINAL	NOMINAL SPEED VELOCIDAD NOMINAL VITESSE NOMINALE GESCHWINDIGKEIT NOMINAL	NOMINAL CURRENT CORRIENTE NOMINAL COURANT NOMINAL NOMINALSTROM	STARTING TORQUE PAR DE-ARRANQUE COUPLE DE DÉMARRAGE ANZUGSDREHMOMENT	STARTING CURRENT CORRIENTE DE ARRANQUE COURANT DE DÉMARRAGE ANLAUFSTROM	SHAFT EJE ARBRE WELLE	CONNECTIONS CONEXIONES CONNEXIONS ANSCHLÜSSART	WIRING DIAGRAM ESQUEMA ELECTRICO SCHEMA ELECTRIQUE SCHALTBILD	APPROXIMATE WEIGHT PESO APROXIMADO POIDS APPROXIMATIF GEWICHT (ca.)	WATERTIGHTNESS GRADO DE ESTANQUEIDAD ÉTANCHEITE FEUCHTIGKEITSSCHUTZKLASSE	DESIGN: A/B DISEÑO: A/B DESSIN: A/B ABBILDUNG: A/B	CURVE CURVA COURBE KURVE
	Un (V)	Mn (N.m./lbf.in)	Fn (r.p.m.)	In (A)	Ma (N.m./lbf.in)	Ia (A)				P (kg/lb)	IP		
16941062004	12	0.40 / 3.54	1900	11	2.0 / 17.7	46	E14	C14	EE2	2.0 / 4.41	IP53	A	45
16941063004	24	0.40 / 3.54	1900	5.5	2.0 / 17.7	23	E14	C14	EE2	2.0 / 4.41	IP53	A	45
16941072004	12	0.40 / 3.54	2900	16	2.2 / 19.4	100	E15	C15	EE2	2.0 / 4.41	IP53	A	46
16941073004	24	0.40 / 3.54	2900	8	2.2 / 19.4	50	E15	C15	EE2	2.0 / 4.41	IP53	A	46
16941102004	12	0.40 / 3.54	1500	9	2.0 / 17.7	38	E16	C16	EE6	2.0 / 4.41	IP53	A	47
16941103004	24	0.40 / 3.54	1500	4.5	2.0 / 17.7	19	E16	C16	EE6	2.0 / 4.41	IP53	A	47
16941132009	12	0.40 / 3.54	3200	16	2.2 / 19.4	85	E18	C18	EE8	1.37 / 3.02	IP53	B	48
16941133009	24	0.40 / 3.54	3200	8	2.2 / 19.4	43	E18	C18	EE8	1.37 / 3.02	IP53	B	48
16941222009	12	0.30 / 2.65	4600	16	1.8 / 15.9	100	E18	C18	EE8	1.37 / 3.02	IP53	B	49

A 2 POLES
2 POLOS
2 PÔLES
2 PHASEN

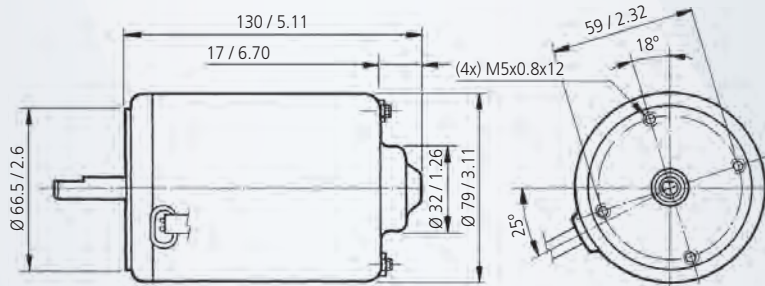

B 4 POLES
4 POLOS
4 PÔLES
4 PHASEN

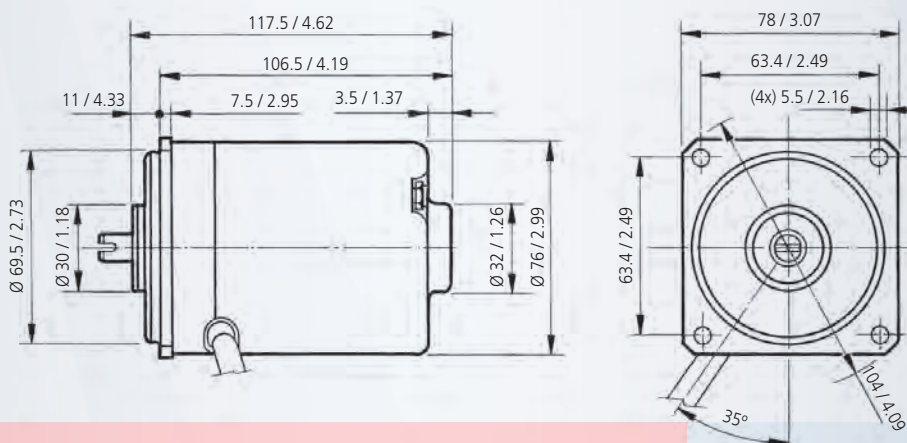

mm / inch

SHAFT EJE ARBRE WELLE

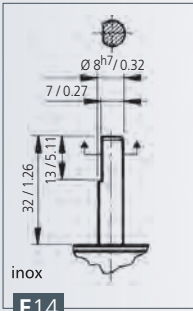

E14

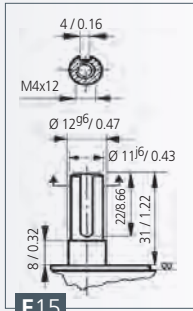

E15

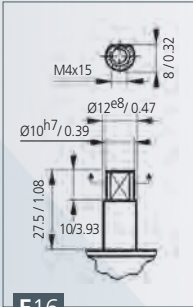

E16

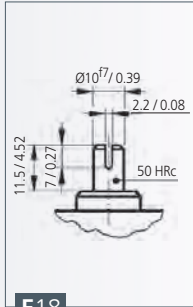

E18

CONNECTIONS CONEXIONES
CONNEXIONS ANSCHLUSSART

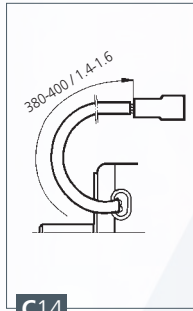

C14

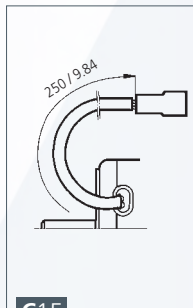

C15

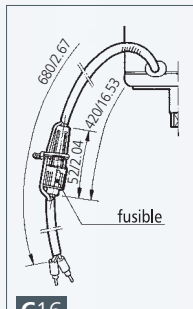

C16

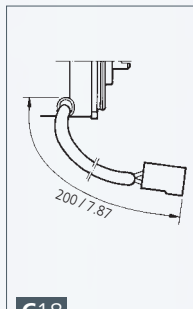

C18

CURVES CURVAS COURBES KURVEN

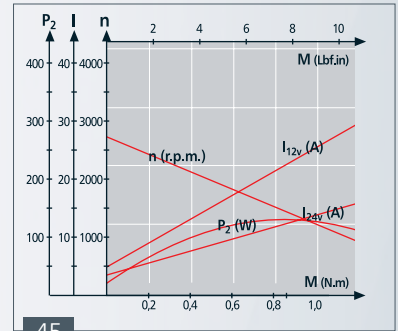

45

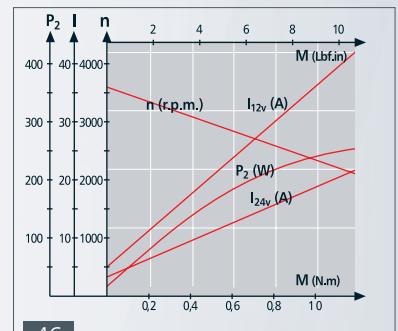

46

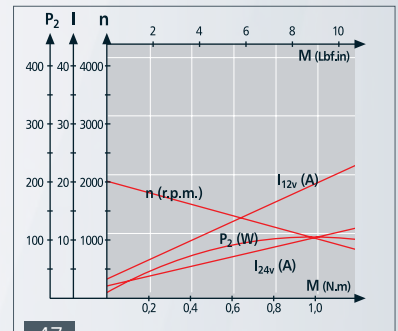

47

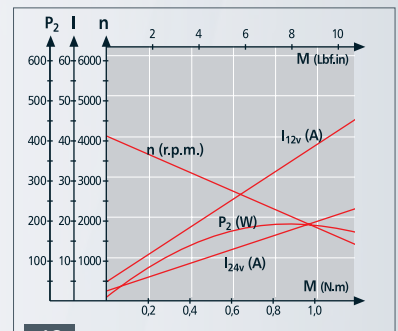

48

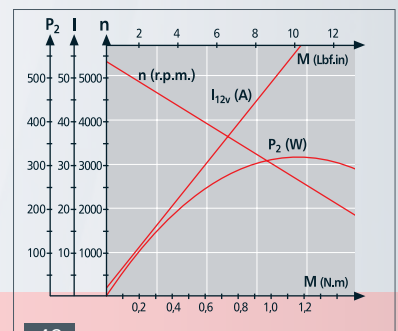

49

WIRING DIAGRAM ESQUEMA ELÉCTRICO
SCHÉMA ÉLECTRIQUE SCHALTBILD

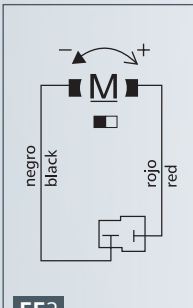

EE2

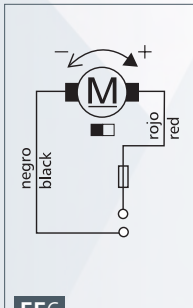

EE6

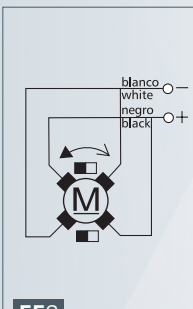

EE8

- **PLANETARY GEAR option:**
See special section in catalogue.
- **REDUCTOR PLANETARIO opcional:**
Ver sección especial en catálogo.
- **RÉDUCTEUR PLANÉTAIRE en option:**
Consultez section spécial du catalogue.
- **Optionales PLANETENGETRIEBE:**
Sehen Sie Sonderabschnitt im Katalog.



A

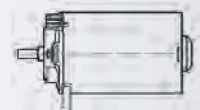

B

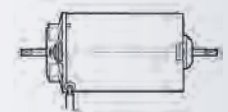

MOTOR FEATURES

REFERENCE NUMBER REFERENCIA REFERENCE REFERENZNUMMERN	NOMINAL VOLTAGE TENSION NOMINAL TENSION NOMINALE NENNSPANNUNG	NOMINAL TORQUE PAR NOMINAL COUPLE NOMINAL DREHMOMENT NOMINAL	NOMINAL SPEED VELOCIDAD NOMINAL VITESSE NOMINALE GESCHWINDIGKEIT NOMINAL	NOMINAL CURRENT CORRIENTE NOMINAL COURANT NOMINAL NOMINALSTROM	STARTING TORQUE PAR DE ARRANQUE COUPLE DE DÉMARRAGE ANZUGSDREHMOMENT	STARTING CURRENT CORRIENTE DE ARRANQUE COURANT DE DÉMARRAGE ANLAUFSTROM	SHAFT EJE ARBRE WELLE	CONNECTIONS CONEXIONES CONNEXIONS ANSCHLUSSART	WIRING DIAGRAM ESQUEMA ELECTRICO SCHEMA ELECTRIQUE SCHALTBIID	APPROXIMATE WEIGHT PESO APROXIMADO POIDS APPROXIMATIF GEWICHT (ca.)	WATER TIGHTNESS GRADO DE ESTANQUEIDAD ÉTANCHÉITÉ FEUCHTIGKEITSSCHUTZKASSE	DESIGN: A-B DISEÑO: A-B DESSIN: A-B ABBILDUNG: A-B	CURVE CURVA COURBE KURVE
	Un (V)	Mn (N.m./lbf.in)	Pn (r.p.m.)	In (A)	Ma (N.m./lbf.in)	Ia (A)				P (kg/lb)	IP		
26941022004	12	0.50 / 4.42	3000	20	4 / 35.4	140	E20	C22	EE2	3.8 / 8.38	IP53	A	52
26941023004	24	0.75 / 6.63	3000	15	4 / 35.4	120	E20	C22	EE2	3.8 / 8.38	IP53	A	53
26941032004	12	0.50 / 4.42	3000	20	4 / 35.4	140	E21	C23	EE2	3.8 / 8.38	IP53	A	52
26941033004	24	0.75 / 6.63	3000	15	4 / 35.4	120	E21	C23	EE2	3.8 / 8.38	IP53	A	53
26941042004	12	0.80 / 7.08	1800	20	4 / 35.4	100	E48	C24	EE2	3.8 / 8.38	IP53	A	54
26941043004	24	0.80 / 7.08	1800	10	4 / 35.4	50	E48	C24	EE2	3.8 / 8.38	IP53	A	54
26941062004	12	0.80 / 7.08	1800	20	4 / 35.4	100	E21	C23	EE2	3.8 / 8.38	IP53	A	54
26941063004	24	0.80 / 7.08	1800	10	4 / 35.4	50	E21	C23	EE2	3.8 / 8.38	IP53	A	54
26941073004E	24	0.75 / 6.63	3000	15	4 / 35.4	120	E48/E11	C22	F2	3.8 / 8.38	IP40	B	53
26941082004E	12	0.80 / 7.08	1800	20	4 / 35.4	100	E48/E11	C24	F2	3.8 / 8.38	IP40	B	54
26941133004	24	0.50 / 4.42	675	2.25	2.7 / 23.8	12	E48	C24	EE2	3.8 / 8.38	IP53	A	55

Flange according to IEC 63 B14 - Puntos de anclaje según IEC 63 B14

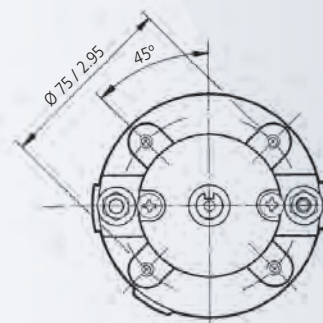
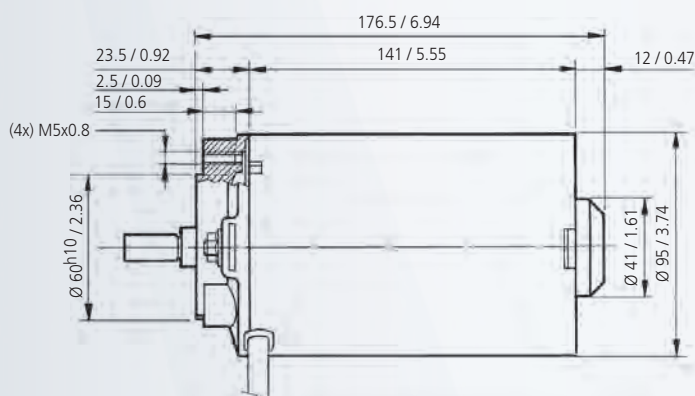

A

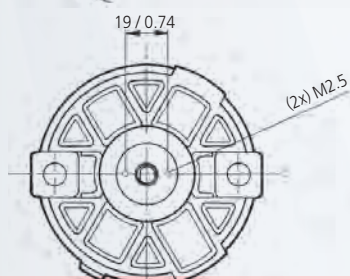

B

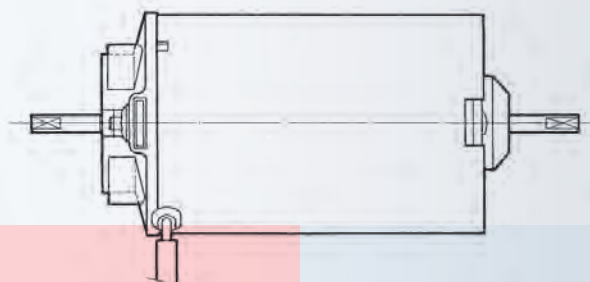

mm / inch

SHAFT EJE ARBRE WELLE

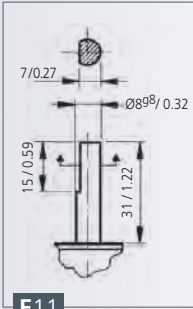

E11

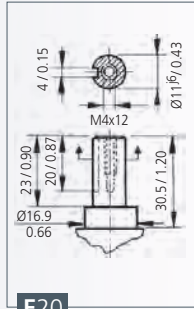

E20

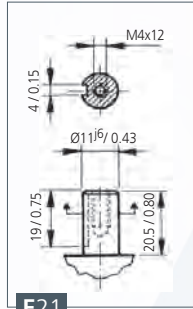

E21

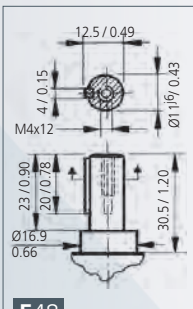

E48

CONNECTIONS CONEXIONES CONNEXIONS ANSCHLUSSART

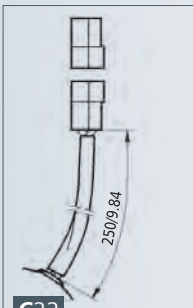

C22

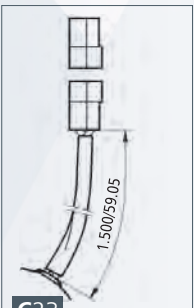

C23

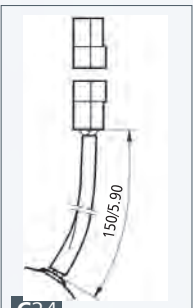

C24

WIRING DIAGRAM ESQUEMA ELÉCTRICO SCHÉMA ÉLECTRIQUE SCHALTBILD

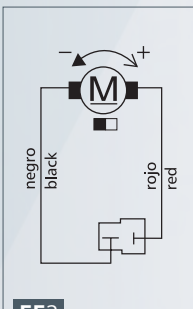

EE2

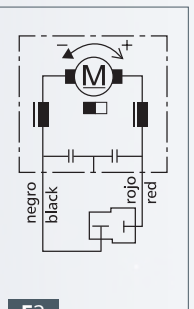

F2

CURVES CURVAS COURBES KURVEN

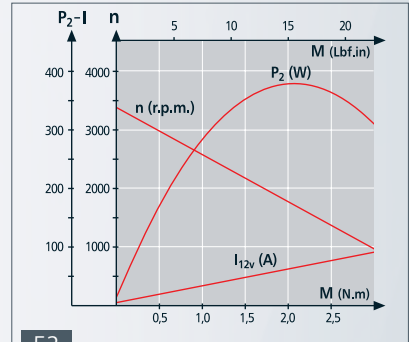

52

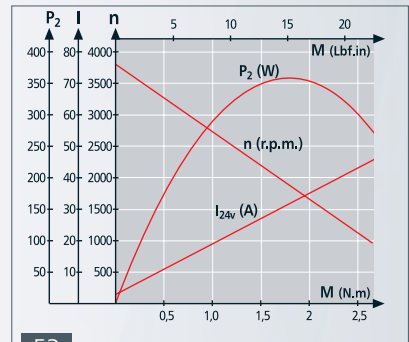

53

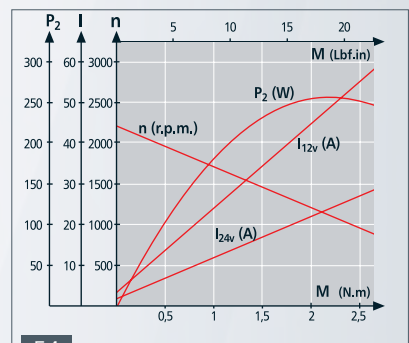

54

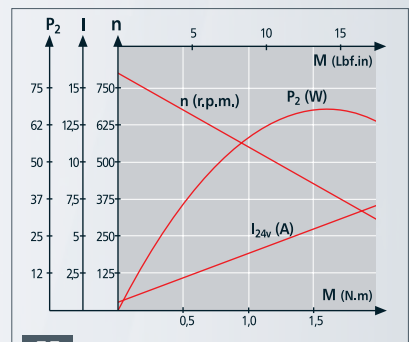

55

321



MOTOR FEATURES

REFERENCE NUMBER REFERENCIA REFERENZ REFERENZNUMMERN	NOMINAL VOLTAGE TENSION NOMINALE NENNSPANNUNG	NOMINAL TORQUE PAR NOMINAL COUPLE NOMINAL DREHMOMENT NOMINAL	NOMINAL SPEED VELOCIDAD NOMINAL VITESSE NOMINALE GESCHWINDIGKEIT NOMINAL	NOMINAL CURRENT CORRIENTE NOMINAL COURANT NOMINAL NOMINALSTROM	STARTING TORQUE PAR DE ARRANQUE COUPLE DE DEMARRAGE ANZUGSDREHMOMENT	STARTING CURRENT CORRIENTE DE ARRANQUE COURANT DE DEMARRAGE ANLAUFSTROM	SHAFT EJE ARBRE WELLE	CONNECTIONS CONEXIONES CONNEXIONS ANSCHLUSSART	WIRING DIAGRAM ESQUEMA ELECTRICO SCHEMA ELECTRIQUE SCHALTBIELD	APPROXIMATE WEIGHT PESO APROXIMADO POIDS APPROXIMATIF GEWICHT (gr)	WATER TIGHTNESS GRADO DE ESTANQUEIDAD ETANCHÉITÉ FEUCHTIGKEITSSCHUTZKLASSE	L	CURVE CURVA COURBE KURVE
	Un (V)	Mn (N.m./lbf.in)	nn (r.p.m.)	In (A)Ma	(N.m./lbf.in)	Ia (A)				P (kg/lb)	IP	(mm/inch)	
32110003009	24	1.9 / 17	2700	27	19 / 168	250	E68	C46	EE17	2.6 / 5.73	IP69K	98 / 3.86	69
32120004009	36	2.7 / 24	2700	28	22 / 195	270	E68	C46	EE17	3.1 / 6.83	IP69K	108 / 4.25	70

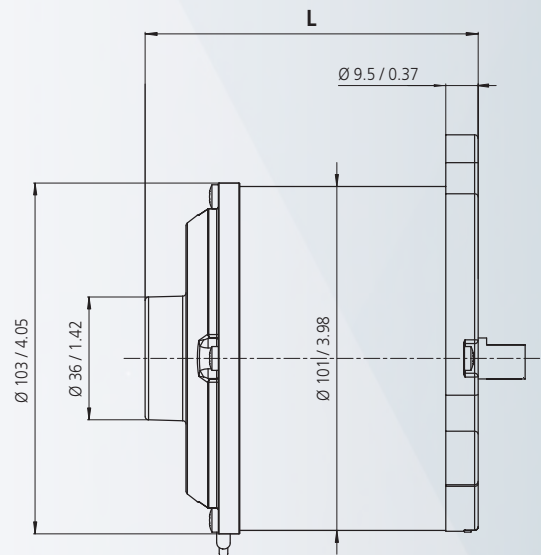
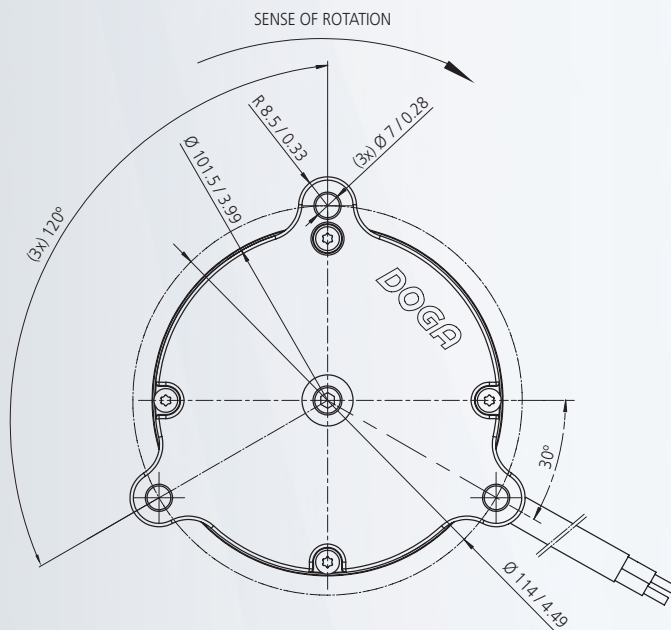

mm / inch

SHAFT EJE ARBRE WELLE

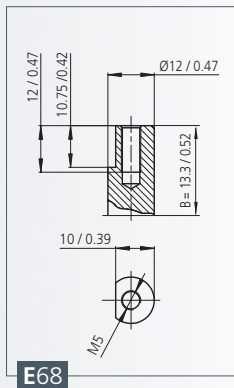

E68

CONNECTIONS CONEXIONES CONNEXIONS ANSCHLUSSART

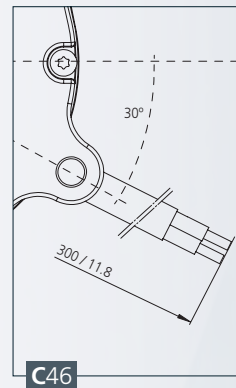

C46

WIRING DIAGRAM ESQUEMA ELÉCTRICO SCHEMA ÉLECTRIQUE SCHALTBILD

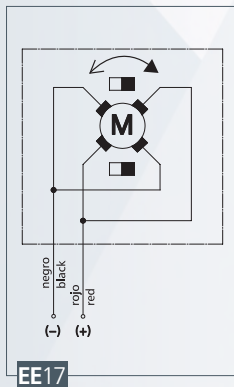

EE17

CURVES CURVAS COURBES KURVEN

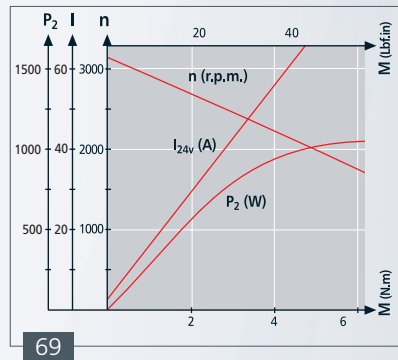

69

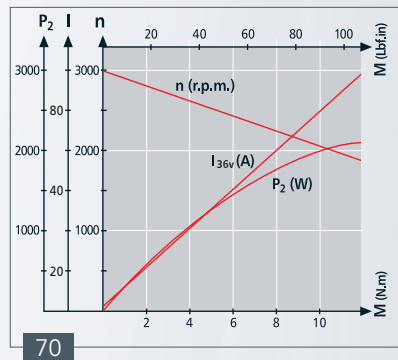

70



STANDARD, CUSTOMIZED
& SPECIAL PROJECTS



PLANETARY GEAR DC MOTORS



DOGA

MOTORES CC CON REDUCTOR PLANETARIO
MOTEURS À CC AVEC RÉDUCTEUR PLANETAIRE
GLEICHSTROMPLANETENGETRIEBEMOTOREN



PLANETARY GEAR DC MOTORS **MOTORES CON REDUCTOR PLANETARIO**
MOTEURS À CC AVEC RÉDUCTEUR PLANETAIRE GLEICHSTROMPLANETENGETRIEBEMOTOREN

		motor ⁽¹⁾ 162	motor ⁽¹⁾ 168	motor ⁽¹⁾ 169	motor ⁽¹⁾ 269	
VOLTAGE TENSIÓN TENSION SPANNUNG		12V standard 24V standard <72V customised	12V standard 24V standard <72V customised	12V standard 24V standard <72V customised	12V standard 24V standard <72V customised	
CONTINUOUS POWER POTENCIA EN SERVICIO CONTÍNUO PUISSANCE EN SERVICE CONTINU DAUERLEISTUNG	<i>W</i>	63	158	122	236	MORE OPTIONS 
	<i>H.P.</i>	0.08	0.21	0.16	0.32	
NOMINAL TORQUE PAR NOMINAL COUPLE NOMINAL NENNDREHMOMENT	<i>N.m.</i>	0.2	0.5	0.4	0.75	
	<i>lbf.in</i>	1.77	4.42	3.54	6.63	
STALL TORQUE PAR DE BLOQUEO COUPLE DE BLOCAGE ANLAUFDREHMOMENT	<i>N.m.</i>	1.0	3.0	2.2	4.0	
	<i>lbf.in</i>	8.85	26.50	19.40	35.4	
DIAMETER DIÁMETRO DIAMETRE DURCHMESSER	<i>mm</i>	60	79	79	95	
	<i>in</i>	2.36	3.11	3.11	3.74	

		Ø 52 mm				Ø 62 mm				Ø 72 mm				Ø 81 mm				
		Ø 2.05 in				Ø 2.44 in				Ø 2.83 in				Ø 3.19 in				
TRANSMISSIONS TRANSMISIÓN TRANSMISSION GETRIEBE		<i>i</i> = (4, 5, 7, 14, 16, 18, 19, 22, 25, 27, 29, 35, 46, 51, 59, 68, 71, 79, 93, 95, 100, 107, 115, 124, 130, 139, 150, 169, 181, 195, 236, 308) : 1																
(2) CONTINUOUS TORQUE PAR EN SERVICIO CONTINUO COUPLE EN SERVICE CONTINU NENNDREHMOMENT	<i>max N.m.</i>	4	12	25	8	25	50	14	42	84	20	60	120					MORE OPTIONS 
	<i>lbf.in</i>	35	106	221	71	221	442	124	372	743	177	531	1062					
	STAGES ▶	1	2	3	1	2	3	1	2	3	1	2	3					
(3) EFFICIENCY LEVEL % RENDIMIENTO % RENDEMENT % WIRKUNGSGRAD %		80%				75%				70%								
STAGES ETAPAS ÉTAGES DE RÉDUCTION STUFE		1				2				3								

- (1) In each motor series we have different power configurations. Here we show one of them. See motor catalogue for others
- (2) The Torque capacity will be precisely defined for each motor and gear combination and for each application. Values indicated per 1, 2 & 3 stages respectively. In certain conditions the mentioned torque can be exceeded.
- (3) Approximate values for each nr. of stages combination.

- (1) Dans chaque série de moteurs nous offrons différentes puissances. Voir page de caractéristiques des moteurs.
- (2) La capacité de couple sera définie pour chaque combinaison de moteur et réducteur ainsi que pour chaque application. Les valeurs sont indiquées pour 1, 2 et 3 étages respectivement. Dans certaines conditions de fonctionnement les valeurs de couple indiquées peuvent être excédées.
- (3) Valeurs approximatives pour chaque n° d'étages.

- (1) En cada serie de motores disponemos de distintas combinaciones de potencia. Ver hojas de características de los motores en el este catálogo.
- (2) La capacidad de par será precisado para cada combinación de motor y reductor y aplicación. Los valores están indicados para 1, 2 o 3 etapas respectivamente. En ciertas condiciones los pares indicados pueden ser excedidos.
- (3) Valores aproximados para cada n° de etapas de reducción.

- (1) Für jede Motorreihe gibt es verschiedene Leistungsvarianten. Hier zeigen wir einige von diesen, für andere Sehen Sie die Motorsektion des Katalogs.
- (2) Das Drehmoment wird genau definiert für jede Motor- und Getriebekombination und für jede Anwendung. Werte für jeweils 1, 2 und 3 Stufen. Unter manche Bedingungen kann das erwähnte Drehmoment überschritten werden.
- (3) Näherungswerte für jede Stufenkombination.

162P

PLANETARY GEAR DC MOTORS MOTORES CON REDUCTOR PLANETARIO
 MOTEURS À CC AVEC RÉDUCTEUR PLANETAIRE GLEICHSTROMPLANETENGETRIEBEMOTOREN



MOTOR

GEAR

REFERENCE NUMBER REFERENCIA REFERENZNUMMERN	REFERENCE NUMBER REFERENCIA REFERENZNUMMERN	NOMINAL VOLTAGE TENSION NOMINAL TENSION NOMINALE NENNSPANNUNG	NO LOAD SPEED VELOCIDAD EN VACÍO VITESSE À VIDE GESCHWINDIGKEIT IM LEERLAUF	(*) CURVE CURBA COURBE KURVE	TRANSMISSION RATIO RELACION DE REDUCCIÓN RAPPORT DE RÉDUCTEUR UNTERSATZUNG	STAGES ETAPAS ETAGES STUFEN	(mm/inch)
	base motor nr. (*)	Un (V)	n0 (r.p.m.)		i		
16290032000	16241012000	12	3500	32	4:1	1	81 / 3.19
16290033000	16241013000	24	3500	33	4:1	1	81 / 3.19
16290042000	16241012000	12	3500	32	16:1	2	95 / 3.74
16290043000	16241013000	24	3500	33	16:1	2	95 / 3.74
16290052000	16241012000	12	3500	32	35:1	2	95 / 3.74
16290053000	16241013000	24	3500	33	35:1	2	95 / 3.74
16290062000	16241012000	12	3500	32	169:1	3	109 / 4.29
16290063000	16241013000	24	3500	33	169:1	3	109 / 4.29

(*) page - página - Seite: 34

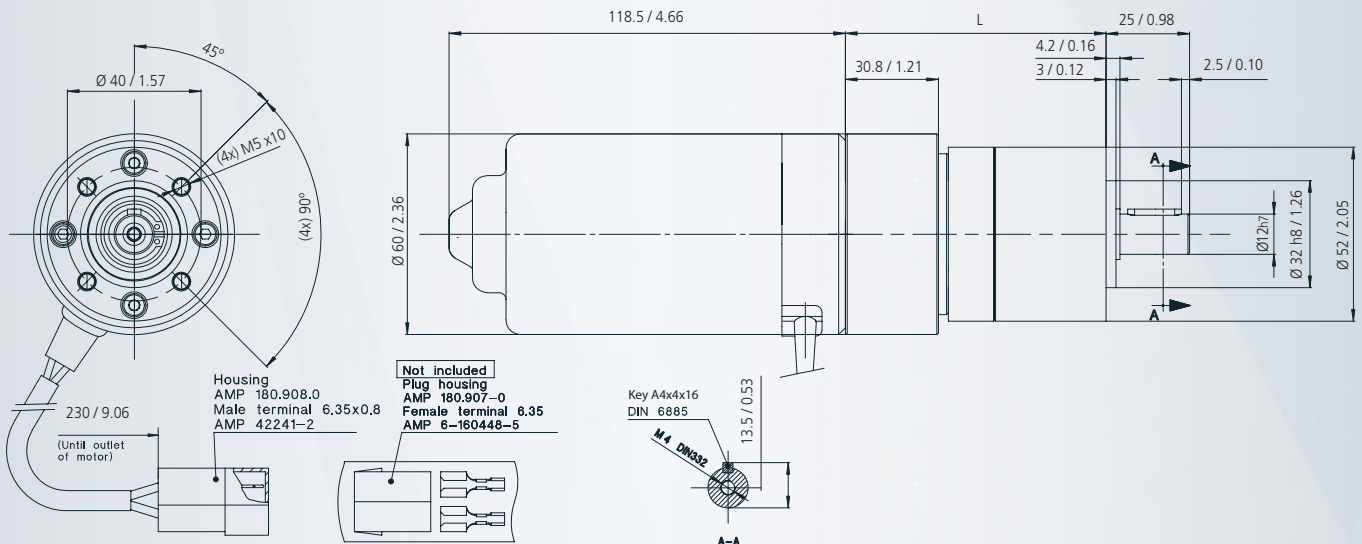

mm / inch



MOTOR

GEAR

REFERENCE NUMBER REFERENCIA REFERENZNUMMERN	base motor nr. (*)	NOMINAL VOLTAGE TENSION NOMINALE NENNSPANNUNG Un (V)	NO LOAD SPEED VELOCIDAD EN VACÍO VITESSE À VIDE GESCHWINDIGKEIT IM LEERLAUF n0 (r.p.m.)	CURVE CURBA KURVE	TRANSMISSION RATIO RELACION DE REDUCCIÓN RAPPORT DE RÉDUCTEUR UNTERSATZUNG i	STAGES ETAPAS STUFEN	(mm/inch)
16841432000	16841082004	12	3200	39	4:1	1	73.2/2.88
16841433000	16841083004	24	3200	39	4:1	1	73.2/2.88
16841442000	16841082004	12	3200	39	25:1	2	90.1/3.55
16841443000	16841083004	24	3200	39	25:1	2	90.1/3.55
16841452000	16841082004	12	3200	39	71:1	3	106.9/4.21
16841453000	16841083004	24	3200	39	71:1	3	106.9/4.21

(*) page- página - Seite: 36

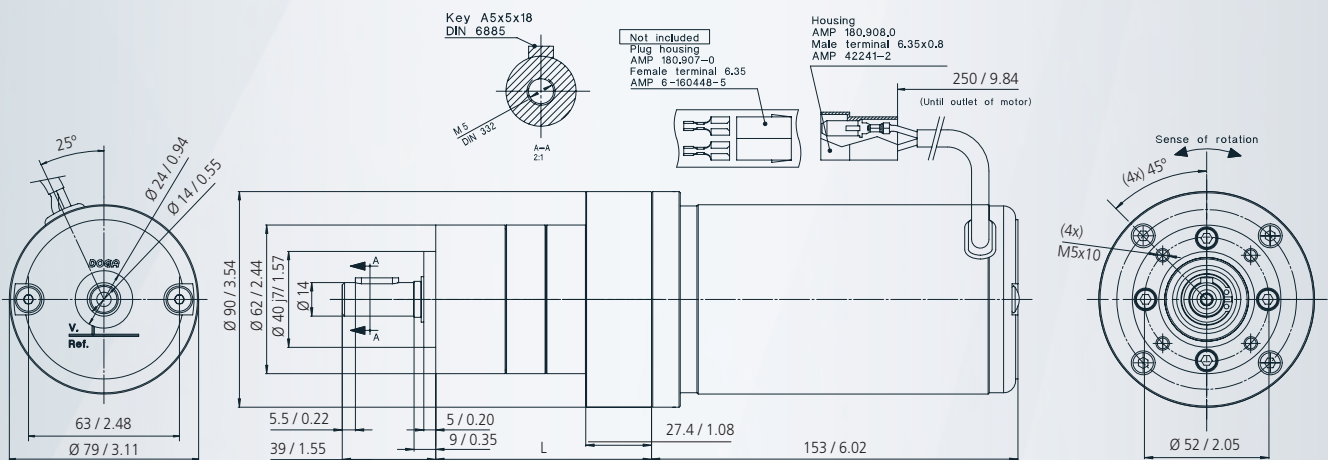



AGRICULTURAL & FARM **AGRICULTURA Y GANADERÍA** AGRICULTURE ET BETAIL **LANDWIRTSCHAFT**

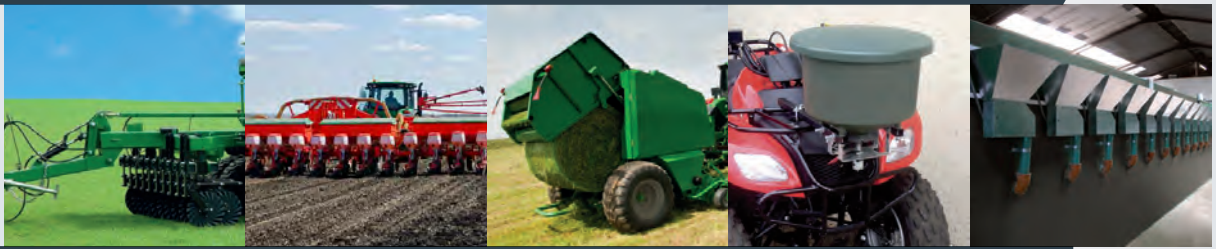

ACCESS & BUILDING **ACCESO Y EDIFICIOS** ACCES ET EDIFICES **ZUGANG UND GEBÄUDE**



CARE AID SYSTEMS **SISTEMAS DE AYUDA A PERSONAS** SYSTEMES D'AIDE AUX PERSONNES **PERSONENBEHILFSEINRICHTUNGEN**

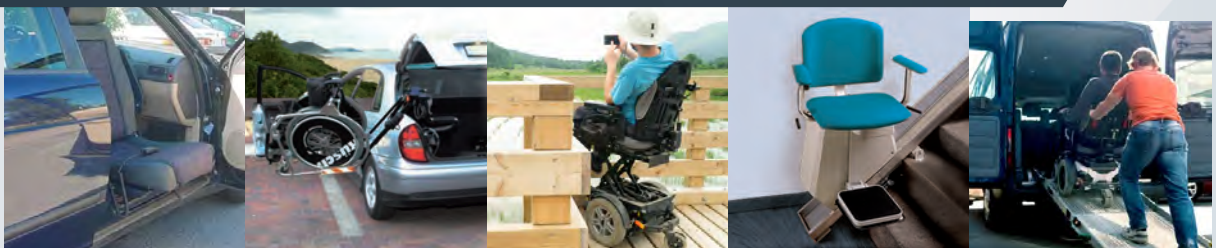

ENERGY **ENERGÍA** ENERGIE **ENERGIE**



MOBILITY **MOVILIDAD** MOBILITÉ **MOBILITÄT**



FOOD INDUSTRY **ALIMENTACIÓN** ALIMENTATION **ERNÄHRUNG**





STANDARD, CUSTOMIZED
& SPECIAL PROJECTS

APPLICATIONS POUR MOTEURS ANWENDUNGSFÄLLE FÜR MOTOREN

HOME HOGAR MAISON HEIM

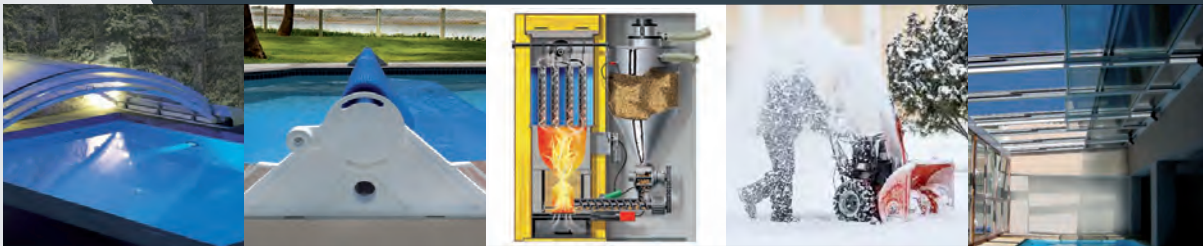

MARINE MARINA MARIN WASSERSPORT



MEDICAL & LAB MEDICINA Y LABORATORIO MEDICAL ET LABORATOIRE MEDIZIN UND LABOR







OFFICE EQUIPMENT EQUIPOS DE OFICINA EQUIPEMENT DE BUREAUX BÜROEINRICHTUNGEN



AND MANY MORE Y MUCHOS MÁS ET PLUS ENCORE UND VIELE MEHR



 CUSTOMIZED MOTORS WITH WORM OR PLANETARY GEAR OR WITH ELECTRONICS. ONE MOTOR FOR EACH APPLICATION.
  **MOTORES A MEDIDA CON MOTORREDUCTOR, REDUCTOR PLANETARIO O CON ELECTRÓNICA. UN MOTOR PARA CADA PROYECTO.**
 MOTEURS SUR MESURE AVEC RÉDUCTEUR, PLANÉTAIRES OU AVEC ÉLECTRONIQUE. UN MOTEUR POUR CHAQUE PROJET.
  **KUNDENSPEZIFISCH ANGEFERTIGTE MOTOREN MIT SCHNECKEN- ODER PLANETARISCHEM GETRIEBE, ODER IN ELEKTRONISCHER AUSFÜHRUNG. EIN MOTOR FÜR JEDWEDE ANWENDUNG!**

EUROPE

DOGA S.A.

HEADQUARTER

Autovía A-2, km. 583
08630 ABRERA - BARCELONA - (SPAIN)
Tel. +34 93 770 46 00
e-mail: doga@dog.es
www.doga.es

AUSTRIA

ELRA Antriebstechnik Vertriebs GmbH

Elraweg 1
A-7093 JOIS
Tel. +43 2160 712 11 0
Fax. +43 2160 712 11 55
e-mail: info@elra.at
www.elra.at

BELGIUM

Act in Time

Satenrozen, 20
B - 2550 KONTICH
Tel. +32 23660606
e-mail: info@actintime.be
www.actintime.be

CZECK REPUBLIC

OEM Automatic, spol. s r.o.

Mr. Tomas Hynek
Pražská 239
250 66 ZDIBY, CZECH REPUBLIC
Tel. +420 241 484 940
Mobile. +420 734 674 807
email: tomas.hynek@oem-automatic.cz
www.oem-automatic.cz

FINLAND

OEM Finland OY

Mr. Andreas Lyrintzis
PL 9
FI-20101 TURKU
Tel. +358-(0)403 412 447
Fax +358 2 07 499 456
e-mail: andreas.lyrintzis@oem.fi
www.oem.fi

FRANCE

MAXON FRANCE SAS

201, rue du Chat Botté
01700 BEYNOST
FRANCE
Tel. +33 (04) 72018300
Fax +33 (04) 72018309
e-mail: contact.fr@maxongroup.com
<https://gamme.mdp.fr/doga-france/>
www.maxongroup.fr

GERMANY

EPH Elektronik Produktions- und Handelsgesellschaft mbH

Rudolf-Diesel-Strasse, 18
D-74354 BESIGHEIM-OTTMARSHEIM
Tel. +49 7143 8152-0
Fax +49 7143 8152-50
e-mail: info@eph-elektronik.de
www.eph-elektronik.de

HUNGARY

CONTRADEX Kereskedelmi Kft.

Mr. Tibor Nardai
Olaj u. 80
8000 SZEKESFEHERVAR
Tel. +36 1 8148801
Fax +36 1 8148813
e-mail: t.nardai@contradex.hu
www.contradex.hu

NETHERLANDS

ERIKS Nederland Aandrijftechniek Schoonhoven

Broeikweg 25
2871 RM SCHOONHOVEN
Tel. +31 888 558 056
e-mail: motioncontrol@eriks.nl
www.eriks.nl

POLAND

OEM Automatic Sp.z.o.o.

Mr. Wojciech Drabik
ul. Działkowa 121A,
02-234 WARSZAWA
Tel. +48 022 863 27 22
Fax +48 022 863 27 24
e-mail: wojciech.drabik@pl.oem.se
www.oemautomatic.pl

PORTUGAL

Onda Radio, S.A.

C/ Les Planes, 1, H - P.I. Font Santa
SANT JOAN DESPI
Tel. +34 93 452 51 07
Fax +34 93 477 50 55
e-mail: fidel@ariston.es
www.ariston.es

RUSSIA

Microprivod Ltd.

Moscow 111141
56 (bldg.32) Shosse Enthusiastov
MOSCOW, 111123
Tel. +7 495 221 4052
Fax +7 495 221 4052
e-mail: info@microprivod.ru
www.microprivod.ru

SPAIN

Onda Radio, S.A.

C/ Les Planes, 1, H - P.I. Font Santa
SANT JOAN DESPI
Tel. +34 93 452 51 07
Fax +34 93 477 50 55
e-mail: fidel@ariston.es
www.ariston.es

**SWEDEN****OEM Motor AB**

Frederiksbergsgatan 2
S-573 92 TRANÅS
Tel. +46 75-24 24 400
e-mail: info@motor.oem.se
www.oemmotor.se

SWITZERLAND**EPH Elektronik Produktions- und
Handelsgesellschaft mbH**

Rudolf-Diesel-Strasse, 18
D-74354 BESIGHEIM-OTTMARSHEIM
Tel. +49 7143 8152-0
Fax +49 7143 8152-50
e-mail: info@eph-elektronik.de
www.eph-elektronik.de

UNITED KINGDOM**OEM Automatic Ltd**

Whiteacres,
Whetstone,
Leicester,
LE8 6ZG
Tel. +44 (0)116 284 9900
e-mail: motors@oem.co.uk
www.oem.co.uk

NORTH AMERICA (USA-CANADA)**DOGA USA, Corp.**

12060 Raymond Court
HUNTLEY - IL - 60142
Tel. +1 847 669 8529
e-mail: dogausa@dogausa.com
www.doga.es

**USA NORTH- EAST
(ME, NM, MA, VT, NY, NJ, CT, RI)****Group Six LLC**

Mr. Ed Crofton
15 Hunting Ridge Drive
SIMSBURY, CT 06070
Tel. +1 860 651 3434
Tel. +1 800 433 3434
Fax +1 860 651 4178
Fax +1 800 200 6963
e-mail: info@grp6.com
www.grp6.com

**USA SOUTH- EAST
(FL, GA, SC, NC, VA, TN, AL)****Jake Rudisill Associates, Inc.**

Mr. William Rudisill
PO Box 36248
CHARLOTTE, NC 28236-6248
Tool Free. +1 800 888 6788
Tel. +1 704 377 6901
Fax +1 704 377 5253
e-mail: info@jakerudisill.com
www.jakerudisill.com

**USA SOUTH- WEST
(AZ, CA, NV)****Foxco Equipment Sales, Inc.**

7071 Warner Avenue #F751
PO Box 2148
Office - 714 596 3600
Toll free fax - 800 428 9857
e-mail: foxcoinfo@foxcoequipment.com
www.foxcoequipment.com

SOUTH AMERICA**DOGA do Brasil, Ltda.**

Mrs. Gislene Nogueira
Rua Ibaiti, 111 / Vila Pernetá / Cond. Portal da Serra
83325-060 PINHAIS - PARANÁ
Tel. +55 41 3668 65 98
e-mail: dogabrasil@dogacom.br
www.dogacom.br

REST OF THE WORLD**DOGA, S.A.****HEADQUARTER**

Autovía A-2, km. 583
08630 ABRERA - BARCELONA - (SPAIN)
Tel. +34 93 770 46 00
e-mail: doga@dogacom.es
www.dogacom.es

www.doga.es



DOGA



DOGAautomotive



@dogasport



@doga_int



EUROPE

DOGA, S.A. (headquarters)

Autovía A-2, Km. 583
08630 ABRERA
BARCELONA - (SPAIN)
Tel. +34 93 770 46 00
e-mail: doga@doga.es

DOGA ITALIA, S.R.L.

Regione Opessina, 44
14040 CASTELNUOVO CALCEA (AT) - (ITALY)
Tel. +39 0141 963000
e-mail: dogaitalia@dogaitalia.com

DOGA PARTS, S.L.U.

Avda. de la Tecnología, 4 P.I. Can Parera
08719 CASTELLOLÍ,
BARCELONA - (SPAIN)
Tel. +34 93 777 88 55
e-mail: info@dogaparts.es
www.dogaparts.es

AMERICA

DOGA DO BRASIL, LTDA.

Rua Ibaiti, 111 - Vila Pernetá - Cond. Portal da Serra
83325-060 PINHAIS
PARANÁ - (BRAZIL)
Tel. +55 41 3668 1513
e-mail: dogabrasil@doga.com.br

DOGA MEXICO COMPONENTES, SA DE C.V.

Avda. Hércules 301-C, Bodega 8
Col. Polígono Industrial Santa Rosa
Km 21 Ctra. Querétaro a San Luis Potosí
Edo. Querétaro CP 76220 - (MEXICO)
Tel. +52 442 291 14 24
e-mail: comercial@dogamexico.com

DOGA USA, CORP.

12060 Raymond Court
Huntley - IL - 60142 - (USA)
Tel. +1 847 669 8529
e-mail: dogausa@dogausa.com

ASIA

DOGA INDIA PVT. LTD.

#13, SNS Chambers 239
Sankey Road
BANGALORE 560 080 - (INDIA)
Tel. +91 80 23614625 - 23615264
e-mail: dogaindia@dogaindia.com

DOGA NANTONG AUTO PARTS CO., LTD.

1 Xindong Road
NanTong Economic & Technology Development Area
226016 NANTONG - JIANGSU - (P.R.CHINA)
Tel. +86 513 8517 5166
e-mail: doganantong@doganantong.com

道佳 (南通) 汽车零配件有限公司
中国江苏省南通经济技术开发区新东路1号 邮
编:226016
电话:+86 513 8517 5166
电子邮件: doganantong@doganantong.com

AFRICA

FAINA TANGER SARL AU

N°79 C2 Zone Franche d'Exportation
90000 TANGER (MOROCCO)
Tel. +212 661228980